



[User Guide](#) | [CG000495](#) | [Rev D](#)

Visium

CytAssist Spatial Gene Expression

Reagent Kits

for Formalin Fixed & Paraffin Embedded (FFPE)

for Fresh Frozen (FF)

for Fixed Frozen (FxF)

For use with:

Visium CytAssist Spatial Gene Expression for FFPE, Human Transcriptome, 6.5 mm, 4 rxns PN-1000520

Visium CytAssist Spatial Gene Expression for FFPE, Mouse Transcriptome, 6.5 mm, 4 rxns PN-1000521

Visium CytAssist Spatial Gene Expression for FFPE, Human Transcriptome, 11 mm, 2 rxns PN-1000522

Visium CytAssist Spatial Gene Expression for FFPE, Mouse Transcriptome, 11 mm, 2 rxns PN-1000523

Visium CytAssist Reagent Accessory Kit, PN-1000499

Visium CytAssist Tissue Slide Cassette, 4 pk, 6.5 mm PN-1000471

Visium CytAssist Tissue Slide Cassette, 4 pk, 11 mm PN-1000472

Dual Index Kit TS Set A, 96 rxns PN-1000251

Notices

Document Number

CG000495 | Rev D

Legal Notices

© 2023 10x Genomics, Inc. (10x Genomics). All rights reserved. Duplication and/or reproduction of all or any portion of this document without the express written consent of 10x Genomics, is strictly forbidden. Nothing contained herein shall constitute any warranty, express or implied, as to the performance of any products described herein. Any and all warranties applicable to any products are set forth in the applicable terms and conditions of sale accompanying the purchase of such product. 10x Genomics provides no warranty and hereby disclaims any and all warranties as to the use of any third-party products or protocols described herein. The use of products described herein is subject to certain restrictions as set forth in the applicable terms and conditions of sale accompanying the purchase of such product. A non-exhaustive list of 10x Genomics' marks, many of which are registered in the United States and other countries can be viewed at: www.10xgenomics.com/trademarks. 10x Genomics may refer to the products or services offered by other companies by their brand name or company name solely for clarity, and does not claim any rights in those third-party marks or names. 10x Genomics products may be covered by one or more of the patents as indicated at: www.10xgenomics.com/patents. The use of products described herein is subject to 10x Genomics Terms and Conditions of Sale, available at www.10xgenomics.com/legal-notices, or such other terms that have been agreed to in writing between 10x Genomics and user. All products and services described herein are intended FOR RESEARCH USE ONLY and NOT FOR USE IN DIAGNOSTIC PROCEDURES.

Instrument & Licensed Software Updates Warranties

Updates to existing Instruments and Licensed Software may be required to enable customers to use new or existing products.

Support

Email: support@10xgenomics.com
10x Genomics
6230 Stoneridge Mall Road
Pleasanton, CA

Document Revision Summary

Document Number

CG000495

Title

Visium CytAssist Spatial Gene Expression Reagent Kits User Guide

Revision

Rev D

Revision Date

March 30, 2023

Specific Changes

- Added references to fixed frozen tissues and accompanying documentation.
- Added Troubleshooting section on delayed addition of Tissue Removal Enzyme to Probe Release Mix.
- Added Troubleshooting section on using the incorrect thermal cycler ramp rate.

General Changes

Updated for general minor consistency of language and terms throughout.

Table of Contents

Introduction	
Reagent Kits	8
10x Genomics Accessories	12
Recommended Thermal Cyclers	12
Recommended Real Time qPCR Systems	13
Imaging System Recommendations	14
Additional Kits, Reagents & Equipment	16
Workflow Overview	19
Protocol Steps & Timing	20
Stepwise Objectives	21
Visium CytAssist Spatial Gene Expression Slides	22
Tips & Best Practices	
Visium Slide Storage	30
Visium Spatial Slide Handling	30
Tissue Slide Handling	31
Visium CytAssist Tissue Slide Cassette	32
Visium CytAssist Tissue Slide Cassette Assembly	34
Visium CytAssist Tissue Slide Cassette Removal	35
Visium Cassette	36
Visium Cassette Assembly	38
Visium Cassette Removal	39
Visium Slide Seal Application & Removal	41
Slide Incubation Guidance	43
Visium CytAssist	
Instrument Orientation	47
Visium CytAssist Tested Slides	48
CytAssist Loading Guidelines	49
Sample Preparation & Staining Guidelines	
Sample Preparation	55
Step 1: Probe Hybridization	
1.0 Get Started	58

Table of Contents

1.1 Probe Hybridization	59
Step 2: Probe Ligation	
2.0 Get Started	64
2.1 Post-Hybridization Wash	65
2.2 Probe Ligation	67
2.3 Post-Ligation Wash	69
Step 3: Probe Release & Extension	
3.0 Get Started	72
3.1 CytAssist Enabled RNA Digestion & Tissue Removal	73
3.2 Probe Extension	82
3.3 Probe Elution	83
Step 4: Pre-Amplification and SPRIselect	
4.0 Get Started	86
4.1 Pre-Amplification	87
4.2 Pre-Amplification Cleanup - SPRIselect	89
Step 5: Visium CytAssist Spatial Gene Expression – Probe-based Library Construction	
5.0 Get Started	91
5.1 Cycle Number Determination – qPCR	92
5.2 GEX Sample Index PCR	94
5.3 GEX Post-Sample Index PCR Cleanup – SPRIselect	96
5.4 GEX Post-Library Construction QC	97
Sequencing	
Sequencing Libraries	99
Sequencing Depth	99
Sequencing Type & Run Parameters	100
Illumina Sequencer Compatibility	100
Sample Indices	101

Table of Contents

Library Loading	101
Troubleshooting	
Bubbles during Coverslipping	103
Bubbles Trapped During Visium CytAssist Run	103
Reagent Flow Failure	104
Visium CytAssist Overheating	105
Slide Popped Off of Visium Slide Stage	105
Number of Washes	105
Tissue Detachment and Folding	107
Tissue Not Within Allowable Area	108
Tissue Outside of Specifications	109
Tissue Segmentation Failure	110
Gasket Obscures Capture Area	111
Visium CytAssist Slide Removal Delayed	112
No qPCR Amplification	112
Flat Line in BioAnalyzer Library Trace	113
Overloaded or Overamplified Trace	114
Delayed Addition of Tissue Removal Enzyme to Probe Release Mix	116
Incorrect Thermal Cycler Ramp Rate	117
Appendix	
Post Library Construction Quantification	119
Agilent TapeStation Traces	120
LabChip Traces	121
Oligonucleotide Sequences	122

Introduction

Reagent Kits	8
10x Genomics Accessories	12
Recommended Thermal Cyclers	12
Recommended Real Time qPCR Systems	13
Imaging System Recommendations	14
Additional Kits, Reagents & Equipment	16
Workflow Overview	19
Protocol Steps & Timing	20
Stepwise Objectives	21
Visium CytAssist Spatial Gene Expression Slides	22

Reagent Kits

Visium CytAssist Spatial Gene Expression for FFPE Reagent Kits

Refer to SDS for handling and disposal information.

Reagent Kits	Part Number	Components	Component Part Number
Visium CytAssist Spatial Gene Expression for FFPE, Mouse Transcriptome, 6.5 mm, 4 rxns*	1000521	Visium CytAssist Slide and Cassettes, 6.5 mm, 2 rxns	PN-1000519
		Visium FFPE Reagent Kit v2 - Small	PN-1000436
		Visium Mouse Transcriptome Probe Kit - Small	PN-1000365
Visium CytAssist Spatial Gene Expression for FFPE, Human Transcriptome, 6.5 mm, 4 rxns*	1000520	Visium CytAssist Slide and Cassettes, 6.5 mm, 2 rxns	PN-1000519
		Visium FFPE Reagent Kit v2 - Small	PN-1000436
		Visium Human Transcriptome Probe Kit v2 - Small	PN-1000466
Visium CytAssist Spatial Gene Expression for FFPE, Mouse Transcriptome, 11 mm, 2 rxns**	1000523	Visium CytAssist Slide and Cassettes, 11 mm, 2 rxns	PN-1000518
		Visium FFPE Reagent Kit v2 - Small	PN-1000436
		Visium Mouse Transcriptome Probe Kit - Small	PN-1000365
Visium CytAssist Spatial Gene Expression for FFPE, Human Transcriptome, 11 mm, 2 rxns**	1000522	Visium CytAssist Slide and Cassettes, 11 mm, 2 rxns	PN-1000518
		Visium FFPE Reagent Kit v2 - Small	PN-1000436
		Visium Human Transcriptome Probe Kit v2 - Small	PN-1000466

*Also available in a pack of 4 as a 16 rxn kit.

**Also available in a pack of 4 as an 8 rxn kit.

Visium CytAssist Slide and Cassettes, 6.5 mm, 2 rxns PN-1000519

Visium CytAssist Slide and Cassettes, 6.5mm 2 rxns PN-1000519 (store at ambient temperature)		
	#	PN
Visium Cassette, 8 port	1	3000811
Visium Tissue Slide Cassette		
Visium CytAssist Sliding Gasket, Small (pre-assembled with translator)	2	3000814
Visium CytAssist Cassette Movable Translator (pre-assembled with gasket)	2	3000816
Visium CytAssist Cassette Movable Frame	2	3000813
Visium Slide Seals, 40-pack	1	2000284
Visium CytAssist Spatial Gene Expression Slide v2, 6.5 mm	1	2000550



Visium CytAssist Slide and Cassettes, 11 mm, 2 rxns PN-1000518

Visium CytAssist Slide and Cassettes, 11mm 2 rxns PN-1000518 (store at ambient temperature)		
	#	PN
Visium Cassette, 2 port	1	3000812
Visium Tissue Slide Cassette		
Visium CytAssist Sliding Gasket, Large	2	3000815
Visium CytAssist Cassette Movable Frame	2	3000813
Visium Slide Seals, 40-pack	1	2000284
Visium CytAssist Spatial Gene Expression Slide v2, 11 mm	1	2000550



Visium CytAssist Tissue Slide Cassette, 6.5 mm, 4 Cassettes PN-1000471

Visium CytAssist Tissue Slide Cassette, 6.5mm 4 Cassettes PN-1000471 (store at ambient temperature)		
	#	PN
Visium CytAssist Sliding Gasket, Small (pre-assembled with translator)	4	3000814
Visium CytAssist Cassette Movable Translator (pre-assembled with gasket)	4	3000816
Visium CytAssist Cassette Movable Frame	4	3000813



Visium CytAssist Tissue Slide Cassette, 11 mm, 4 Cassettes PN-1000472

Visium CytAssist Tissue Slide Cassette, 11mm 4 Cassettes PN-1000472 (store at ambient temperature)		
	#	PN
Visium CytAssist Sliding Gasket, Large	4	3000815
Visium CytAssist Cassette Movable Frame	4	3000813



Visium FFPE Reagent Kit v2 – Small, PN-1000436

Visium FFPE Reagent Kit - Small PN-1000436 (store at -20°C)			
		#	PN
○	Amp Mix B	1	2000567
●	Extension Enzyme	1	2000389
●	Extension Buffer	1	2000409
●	RNase Enzyme	1	3000593
●	RNase Buffer B	1	2000551
●	Tissue Removal Enzyme	1	3000387
●	Tissue Removal Buffer B*	1	2000543
●	Tissue Removal Buffer Enhancer*	1	2000557
●	Decrosslinking Buffer	1	2000566
●	TS Primer Mix B	1	2000537
●	Block and Stain Buffer	2	2000554



*These tubes may not be included in the kit. They are not used in this assay.

Visium Human Transcriptome Probe Kit v2 - Small, PN-1000466

Visium Human Transcriptome Probe Kit v2 - Small PN-1000466 (store at -20°C)			
		#	PN
<input type="radio"/>	FFPE Hyb Buffer	1	2000423
<input type="radio"/>	FFPE Post-Hyb Wash Buffer	1	2000424
<input checked="" type="radio"/>	Human WT Probes v2 - RHS	1	2000657
<input checked="" type="radio"/>	Human WT Probes v2 - LHS	1	2000658
<input type="radio"/>	Probe Ligation Enzyme	1	2000425
<input type="radio"/>	2X Probe Ligation Buffer	1	2000445
	Post Ligation Wash Buffer	1	2000419

10x
GENOMICS

Visium Mouse Transcriptome Probe Kit - Small, PN-1000365

Visium Mouse Transcriptome Probe Kit - Small PN-1000363 (store at -20°C)			
		#	PN
<input type="radio"/>	FFPE Hyb Buffer	1	2000423
<input type="radio"/>	FFPE Post-Hyb Wash Buffer	1	2000424
<input checked="" type="radio"/>	Mouse WT Probes - RHS	1	2000455
<input checked="" type="radio"/>	Mouse WT Probes - LHS	1	2000456
<input type="radio"/>	Probe Ligation Enzyme	1	2000425
<input type="radio"/>	2X Probe Ligation Buffer	1	2000445
	Post Ligation Wash Buffer	1	2000419

10x
GENOMICS

Dual Index Kit TS Set A, 96 rxns PN-1000251

Dual Index Kit TS Set A 96 rxns PN-1000251 (store at -20°C)		
	#	PN
Dual Index Plate TS Set A	1	3000511

10x Genomics Accessories

Product	#	Kit and Part Number	Part Number (Item)
10x Magnetic Separator	1	Visium CytAssist Reagent Accessory Kit 1000499	120250
Low Profile Thermocycler Adapter	2		3000823

Recommended Thermal Cyclers

Supplier	Description	Part Number
Bio-Rad	C1000 Touch Thermal Cycler with 96-Deep Well Reaction Module	1851197
Eppendorf	MasterCycler Pro (discontinued)	North America 950030010 International 6321 000.019
	MasterCycler X50s	North America 6311000010
Thermo Fisher Scientific	Veriti 96-Well Thermal Cycler (discontinued)	4375786
Analytik Jena	Biometra TAdvanced 96 SG with 96-well block (silver, 0.2 mL) and gradient function	846-x-070-241



If using thermal cyclers other than BioRad C1000, ramp rates should be adjusted for all the steps as described below

- Eppendorf MasterCycler X50s: 3°C/sec heating and 2°C/sec cooling
- Analytik Jena Biometra TAdvanced: 2°C/sec heating and cooling

Thermal cycler requirements if reactions are performed on a tube:

- Uniform heating of 100 ul volumes
- Temperature-controlled lid
- 96 deep-well block or 0.2 ml block configuration

Thermal cycler requirements if reactions are performed on a slide:

- The thermal cycler must be able to accommodate the low profile plate insert (also referred to as the Low Profile Thermocycler Adapter):
 - Well depth: 4.5 mm
 - Distance between block and heated lid: 12 mm
 - Reaction block dimensions: 95.5 x 73 mm
- The Low Profile Thermocycler Adapter may be difficult to remove from some thermal cyclers. If this is the case, turn off the thermal cycler and place a -20°C cooling pad on top of the Low Profile Thermocycler Adapter for a few minutes prior to attempting removal. Do not handle the Low Profile Thermocycler Adapter while it is hot.

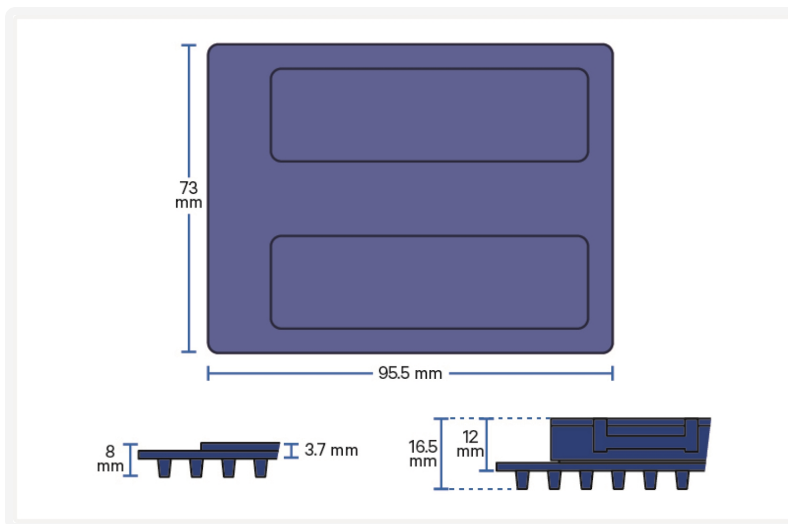

Recommended Real Time qPCR Systems

Supplier	Description	Part Number
Applied Biosystems	QuantStudio 12K Flex system	4471087
Bio-Rad	CFX96 Real-time System (discontinued)	1855096

Imaging System Recommendations

The imaging systems listed below were used by 10x Genomics. Any equivalent system with the listed features may be used for imaging. Consult the Visium CytAssist Spatial Gene Expression Imaging Guidelines Technical Note (CG000521) for more information.

Imaging Systems & Specifications		
Microscopes (Any equivalent system with the listed features may be used for imaging)		
Supplier	Model	Configuration
Thermo Fisher Scientific	EVOS M7000	Inverted
Leica	Aperio Versa 8	Upright
	Leica DMI8	Inverted
MetaSystems	Metafer	Upright
Nikon	Nikon Eclipse Ti2	Inverted
BioTek	Cytation 7	Inverted or Upright
Keyence	Keyence BZX800	Inverted
Olympus	VS200	Upright
Zeiss	Imager.Z2	Upright
Microscope Features		
Objectives	<ul style="list-style-type: none"> • 10X (NA 0.45) • 20X (NA 0.75) • 40X (NA 0.95) 	
Brightfield Features (for H&E staining)	<ul style="list-style-type: none"> • Color camera (3 x 8 bit, 2,424 x 2,424 pixel resolution) • White balancing functionality • Minimum Capture Resolution 2.18 μm/pixel • Exposure times 2-10 milli sec 	
Fluorescence Features (for IF Staining of FFPE tissues)	<ul style="list-style-type: none"> • Light source (or equivalent) with a wavelength range of 380-680 nm • Monochrome camera (14 bit, 2,424 x 2,424 pixel resolution) 	

Imaging Systems & Specifications

- DAPI filter cube (Excitation 392/23, Emission 447/60)
- FITC filter cube (Excitation 466/40, emission 515/30)
- Cy5 filter cube (Excitation 618/50, Emission 698/70)
- TRITC filter cube (Excitation 542/20, Emission 620/52)
- Minimum Capture Resolution 2.18 $\mu\text{m}/\text{pixel}$
- Exposure times 100 milli sec-2 sec

Additional Specifications

Image Format	Save image as a tiff (preferred) or jpeg
Computer	Computer with sufficient power to handle large images (0.5-5 GB)
Software	Image stitching software (microscope's imaging software or equivalent, like ImageJ)

Additional Kits, Reagents & Equipment

The items in the table below have been validated by 10x Genomics and are highly recommended for the Visium Spatial Reagent Kits protocols. **Substituting materials may adversely affect system performance.** This list does not include standard laboratory equipment such as water baths, centrifuges, vortex mixers, pH meters, freezers etc.

Item	Description	Supplier	Part Number (US)
Plastics			
1.5 ml tubes	DNA LoBind Tubes, 1.5 ml	Eppendorf	022431021
	Low DNA Binding Tubes, 1.5 ml	Sarstedt	72.706.700
2.0 ml tubes (when processing more than 2 slides)	DNA LoBind Tubes, 2.0 ml	Eppendorf	022431048
	Low DNA Binding Tubes, 2.0 ml	Sarstedt	72.695.700
15 ml tubes	15 ml PP Centrifuge Tubes	Corning	430791
50 ml tubes	Self-Standing Polypropylene Centrifuge Tubes (50 ml), sterile	Corning	430921
0.2 ml PCR 8-tube strips	PCR Tubes 0.2 ml 8-tube strips	Eppendorf	951010022
<i>Choose either Eppendorf, USA Scientific, or Thermo Fisher Scientific PCR 8-tube strips</i>	TempAssure PCR 8-tube strip	USA Scientific	1402-4700
	MicroAmp 8-Tube Strip, 0.2 ml (see Tips & Best Practices for more information)	Thermo Fisher Scientific	N8010580
	MicroAmp 8 -Cap Strip, clear (see Tips & Best Practices for more information)	Thermo Fisher Scientific	N8010535
Slide mailer/tube	Simport Scientific LockMailer Tamper Evidence Slide Mailer (alternatively, use a 50-ml centrifuge tube)	Thermo Fisher Scientific	22-038-399
	Self-Standing Polypropylene Centrifuge Tubes (50 ml), sterile	Corning	430921
PCR plates and sealing film	Hard-shell PCR Plates 96-well, thin wall (pkg of 50) (Or any compatible PCR Plate)	Bio-Rad	HSP9665
	Microseal 'B' PCR Plate Sealing Film, adhesive (Or any compatible PCR Plate sealing adhesive)	Bio-Rad	MSB1001
Pipette tips	Tips LTS 200UL Filter RT-L200FLR	Rainin	30389240

Item	Description	Supplier	Part Number (US)
	Tips LTS 1ML Filter RT-L1000FLR	Rainin	30389213
	Tips LTS 20UL Filter RT-L20FLR	Rainin	30389226
Wide Bore Pipette tips	Tips RT LTS 200UL FLW	Rainin	30389241
	Tips RT LTS 1000UL FLW	Rainin	30389218
Reagent Reservoirs	Divided Polystyrene Reservoirs	VWR	41428-958
Kits & Reagents			
Nuclease-free Water (not DEPC treated)	Nuclease-free Water	Thermo Fisher Scientific	AM9937
Tris 1M	Tris 1M, pH 8.0, RNase-free	Thermo Fisher Scientific	AM9855G
	Tris 1M, pH 8.0	TEKONOVA	T5080
	UltraPure 1M Tris-HCl, pH 8.0	Invitrogen	15568025
10X PBS	PBS - Phosphate Buffered Saline (10X) pH 7.4, RNase-free	Thermo Fisher Scientific	AM9624
Tween 20	Tween 20 Surfact-Amps Detergent Solution (10% solution)	Thermo Fisher Scientific	28320
qPCR Mix	KAPA SYBR FAST qPCR Master Mix (2X)	KAPA Biosystems (US Only) Millipore Sigma (Europe, Asia, & Canada)	KK4600
SPRIselect Reagent	SPRIselect Reagent Kit	Beckman Coulter	B23318
Ethanol	Ethyl alcohol, Pure (200 Proof, anhydrous)	Millipore Sigma	E7023-500ML
8M KOH	Potassium Hydroxide Solution, 8M	Millipore Sigma	P4494-50ML
20X SSC Buffer	SSC Buffer 20X Concentrate	Millipore Sigma	S66391L
Buffer EB	Qiagen Buffer EB	Qiagen	19086
Eosin	Eosin Y solution, alcoholic	Millipore Sigma	HT110116
	Eosin Y Solution (Modified Alcoholic)	Abcam	ab246824
	Eosin Y with Phloxine 1% alcoholic solution	VWR	10143
Ultrapure Water	Ultrapure/Milli-Q water (from Milli-Q Integral Ultrapure Water System or equivalent)		
Equipment			
Pipettes	Pipet-Lite Multi Pipette L8-200XLS+	Rainin	17013805
	Pipet-Lite LTS Pipette L-2XLS+	Rainin	17014393

Item	Description	Supplier	Part Number (US)
	Pipet-Lite LTS Pipette L-10XLS+	Rainin	17014388
	Pipet-Lite LTS Pipette L-20XLS+	Rainin	17014392
	Pipet-Lite LTS Pipette L-100XLS+	Rainin	17014384
	Pipet-Lite LTS Pipette L-200XLS+	Rainin	17014391
	Pipet-Lite LTS Pipette L-1000XLS+	Rainin	17014382
Mini Centrifuge	VWR Mini Centrifuge (or any equivalent mini centrifuge)	VWR	76269-064
Quantification & Quality Control			
<i>Choose Bioanalyzer, TapeStation, or LabChip based on availability & preference.</i>			
Bioanalyzer & associated reagents	2100 Bioanalyzer Laptop Bundle (discontinued)	Agilent	G2943CA
	Replacement 2100 Bioanalyzer Instrument/2100 Expert Laptop Bundle	Agilent	G2939BA/G2953CA
	High Sensitivity DNA Kit	Agilent	5067-4626
TapeStation & associated reagents	4200 TapeStation	Agilent	G2991AA
	High Sensitivity D1000 ScreenTape/Reagents	Agilent	5067-5584/ 5067-5585
	High Sensitivity D5000 ScreenTape/Reagents	Agilent	5067-5592/ 5067-5593
LabChip & associated reagents	LabChip GX Touch HT Nucleic Acid Analyzer	PerkinElmer	CLS137031
	DNA High Sensitivity Reagent Kit	PerkinElmer	CLS760672
Qubit & associated reagents (for determining dilution factor for TapeStation or Bioanalyzer)	Qubit Fluorometer	ThermoFisher Scientific	Q33238
	Qubit Assay Tubes	ThermoFisher Scientific	Q32856
	Qubit dsDNA HS and BR Assay Kits	ThermoFisher Scientific	Q32854
Library Quantification Kit	KAPA Library Quantification Kit for Illumina Platforms	KAPA Biosystems	KK4824

Workflow Overview

Formalin Fixed & Paraffin Embedded

Tissue Preparation Guide
QC tissue blocks; section tissue onto slides; QC and process archived slides
Demonstrated Protocol CG000518

Imaging Guidelines
Optimize imaging settings for Visium CytAssist Spatial Gene Expression workflow.
Technical Note CG000521

Choose one Demonstrated Protocol

Deparaffinization + H&E Staining + Decrosslinking
Deparaffinize, stain, image, and decrosslink tissue.
Demonstrated Protocol CG000520

Deparaffinization + Decrosslinking + IF Staining
Deparaffinize, decrosslink, stain, and image tissue.
Demonstrated Protocol CG000519

Library Construction
Construct Visium CytAssist Spatial Gene Expression - Probe-based libraries.
User Guide CG000495

Fresh Frozen

Tissue Preparation Guide
Freeze and embed tissue; QC tissue block; Section tissue onto slides
Demonstrated Protocol CG000636

Imaging Guidelines
Optimize imaging settings for Visium CytAssist Spatial Gene Expression workflow.
Technical Note CG000521

Only H&E staining has been validated for FF tissues.

MeOH Fixation + H&E Staining + Destaining
Fix, stain, image, and destain tissue.
Demonstrated Protocol CG000614

Library Construction
Construct Visium CytAssist Spatial Gene Expression - Probe-based libraries.
User Guide CG000495

Fixed Frozen

Tissue Preparation Guide
Fix and embed tissue; QC tissue block; Section tissue onto slides
Demonstrated Protocol CG000663





Imaging Guidelines
Optimize imaging settings for Visium CytAssist Spatial Gene Expression workflow.
Technical Note CG000521

Only H&E staining has been validated for FxF tissues.

Rehydration + H&E Staining + Decrosslink
Rehydrate, stain, image, and decrosslink tissue.
Demonstrated Protocol CG000662

Library Construction
Construct Visium CytAssist Spatial Gene Expression - Probe-based libraries.
User Guide CG000495

Protocol Steps & Timing

Steps	Timing	Stop & Store
Day 1		
Step 1: Probe Hybridization (page 57)		
1.1 Probe Hybridization (page 59)	Overnight	
Day 2		
Step 2: Probe Ligation (page 63)		
2.1 Post-Hybridization Wash (page 65)	20 min	
2.2 Probe Ligation (page 67)	65 min	
2.3 Post-Ligation Wash (page 69)	15 min	 4°C ≤24 h
Step 3: Probe Release & Extension (page 71)		
3.1 CytAssist Enabled RNA Digestion & Probe Release	40 min	
3.2 Probe Extension (page 82)	20 min	 4°C ≤24 h
3.3 Probe Elution (page 83)	15 min	
Step 4: Pre-Amplification and SPRIselect (page 85)		
4.1 Pre-Amplification (page 87)	40 min	
4.2 Pre-Amplification Cleanup - SPRIselect (page 89)	30 min	 4°C ≤72 h or -20°C ≤4 weeks
Step 5: Visium CytAssist Spatial Gene Expression – Probe-based Library Construction (page 90)		
5.1 Cycle Number Determination – qPCR (page 92)	45 min	
5.2 GEX Sample Index PCR (page 94)	40 min	
5.3 GEX Post-Sample Index PCR Cleanup – SPRIselect (page 96)	30 min	 -20°C long-term
5.4 GEX Post-Library Construction QC (page 97)	50 min	

Stepwise Objectives

The Visium CytAssist Spatial Gene assay is designed to analyze mRNA in tissue sections derived from formalin fixed & paraffin embedded (FFPE), fresh frozen (FF), or fixed frozen (FxF) tissue samples. It uses probes targeting the whole transcriptome. Each Visium CytAssist Spatial Gene Expression Slide contains Capture Areas with barcoded spots that include oligonucleotides required to capture gene expression probes. Before the assay, tissue sections are processed as described in their relevant Demonstrated Protocol. Refer to [Workflow Overview on page 19](#) for documentation references.

Human or mouse whole transcriptome probe panels, consisting of ~1 (mouse) or ~3 pairs (human) of specific probes for each targeted gene are added to the tissue, enabling hybridization and ligation of each probe pair. Tissue slides and Visium CytAssist Spatial Gene Expression v2 Slides are loaded into the Visium CytAssist instrument, where they are brought into proximity with one another. Gene expression probes are released from the tissue upon CytAssist Enabled RNA Digestion & Tissue Removal, enabling capture by the spatially barcoded oligonucleotides present on the Visium slide surface. The Visium CytAssist Spatial Gene Expression v2 Slide is removed from the Visium CytAssist for downstream library preparation. Gene expression libraries are generated from each tissue section and sequenced. Spatial Barcodes are used to associate the reads back to the tissue section images for spatial mapping of gene expression.

This document outlines the protocol for generating Visium CytAssist Spatial Gene Expression - Probe-based libraries. While this User Guide provides guidance on using both human and mouse probes, only mouse probes have been validated with the FxF assay.

Visium CytAssist Spatial Gene Expression Slides

Visium CytAssist Spatial Gene Expression Slide v2, 6.5 mm

The CytAssist Spatial Gene Expression Slide v2, 6.5 mm has 2 Capture Areas. Each Capture Area is 6.5 x 6.5 mm and defined by a fiducial frame (fiducial frame + Capture Area is 8 x 8 mm). The Capture Area has ~5,000 barcoded spots. Each spot has the following oligos:

- Gene Expression: Illumina TruSeq partial read 1 sequencing primer, 16 nucleotide (nt) Spatial Barcode, 12 nt unique molecular identifier (UMI), 30 nt poly(dT) sequence (captures ligation product).
- Each Capture Area on the CytAssist Spatial Gene Expression Slide is surrounded by a spacer. This spacer creates a reaction chamber that facilitates proper reagent addition and creates a seal between the CytAssist Spatial Gene Expression Slide and the tissue slide.
- The active surface of the slide is defined by a readable label that includes the serial number.

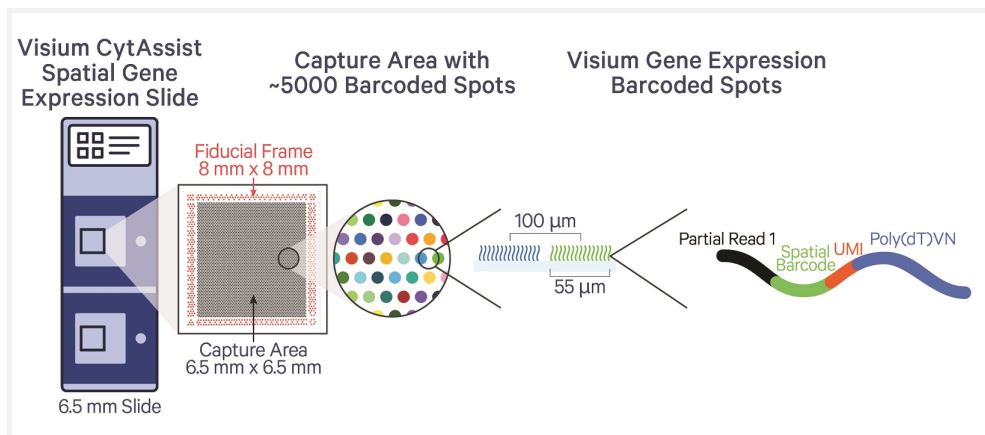

Visium CytAssist Spatial Gene Expression Slide v2, 11 mm

The CytAssist Spatial Gene Expression Slide v2, 11 mm has 2 Capture Areas. Each Capture Area is 11 x 11 mm and defined by a fiducial frame (fiducial frame + Capture Area is 12.5 x 12.5 mm). The Capture Area has ~14,000 barcoded spots. Each spot has the following oligos:

- Gene Expression: Illumina TruSeq partial read 1 sequencing primer, 16 nt Spatial Barcode, 12 nt unique molecular identifier (UMI), 30 nt poly(dT) sequence (captures ligation product).
- Each Capture Area on the CytAssist Spatial Gene Expression Slide is surrounded by a spacer. This spacer creates a reaction chamber that facilitates proper reagent addition and creates a seal between the CytAssist Spatial Gene Expression Slide and the tissue slide.
- The active surface of the slide is defined by a readable label that includes the serial number.

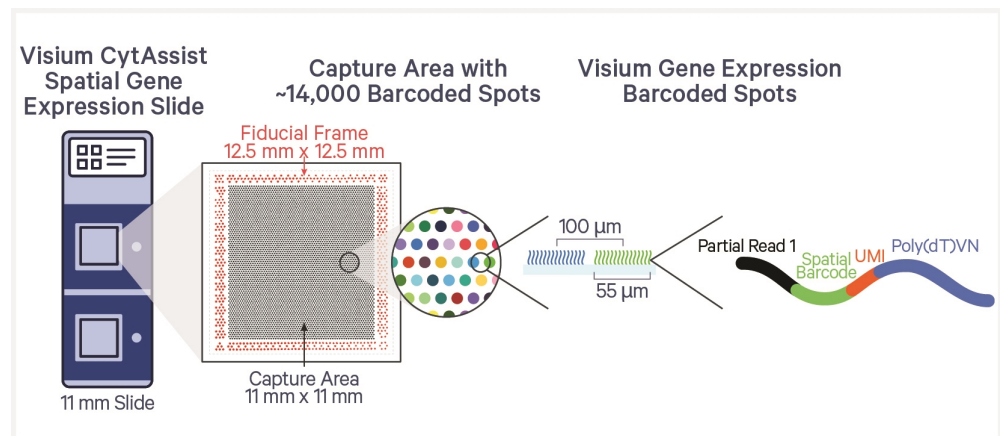

Step 1: Probe Hybridization

The human or mouse whole transcriptome probe panel, consisting of ~3 or ~1 specific probes for each targeted gene respectively, is added to the deparaffinized, stained, and decrosslinked tissues. Together, probe pairs hybridize to their complimentary target RNA.

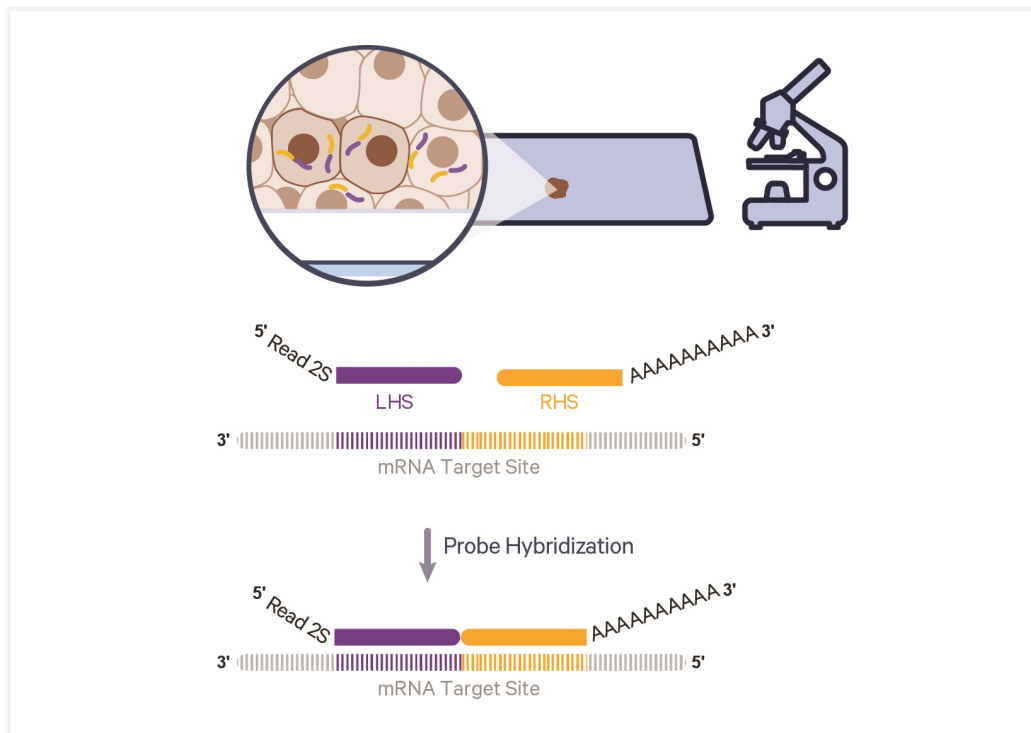

Step 2: Probe Ligation

After hybridization, a ligase is added to seal the junction between the probe pairs that have hybridized to RNA, forming a ligation product.

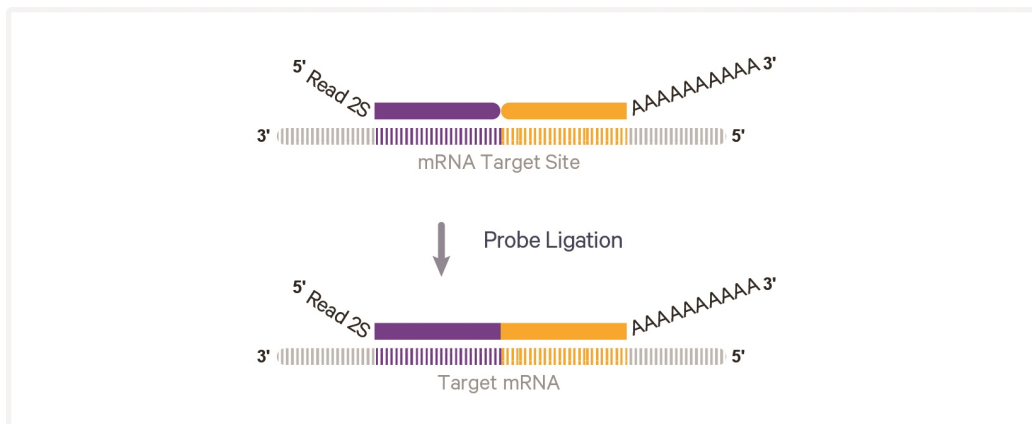

Step 3: Probe Release & Extension

This step occurs in the Visium CytAssist instrument. The single stranded ligation products are released from the tissue upon RNase treatment and tissue removal, and then captured on the Visium slides. Once ligation products are captured, the slides can be removed from the instrument. Analytes are extended by incorporating addition of UMI, Spatial Barcode, and partial Read 1. This generates spatially barcoded, ligated probe products, which can then be carried forward for library preparation.

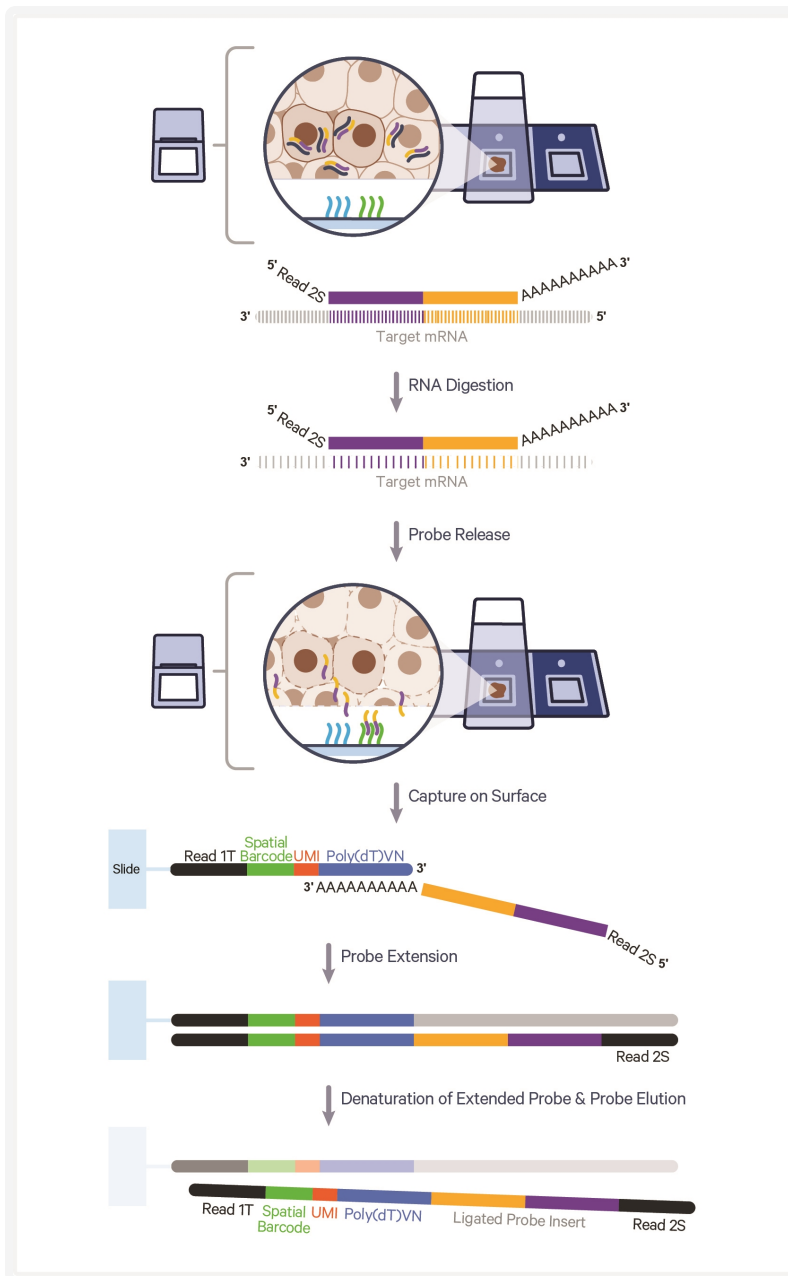

Step 4: Pre-amplification and SPRIselect

To generate ample material for library construction, barcoded ligation products are amplified. This pre-amplification is followed by cleanup by SPRIselect.

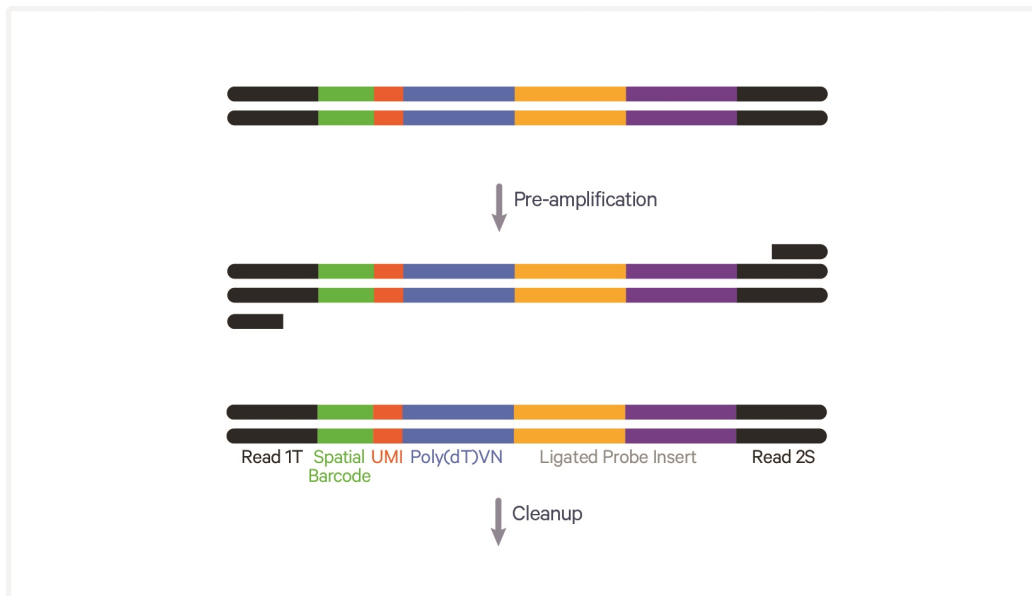

Step 5: Visium CytAssist Spatial Gene Expression - Probe-based Library Construction

Pre-amplification material is collected for qPCR to determine Sample Index PCR cycle number for gene expression libraries. The amplified material then undergoes indexing via Sample Index PCR generating final library molecules. The final libraries are cleaned up by SPRIselect, assessed on a bioanalyzer or a similar instrument, quantified, and then sequenced.

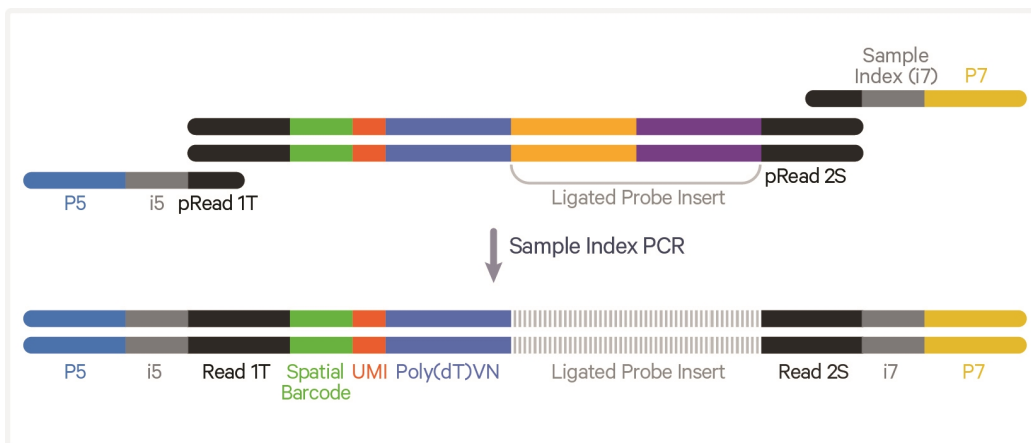

Sequencing

A Visium CytAssist Spatial Gene Expression - Probe-based library comprises standard Illumina paired-end constructs which begin and end with P5 and P7 adaptors. The 16 bp Spatial Barcode and 12 bp UMI are encoded in TruSeq Read 1, while Small RNA Read 2 (Read 2S) is used to sequence the ligated probe insert.

Illumina sequencer compatibility, sample indices, library loading and pooling for sequencing are summarized in step 8.

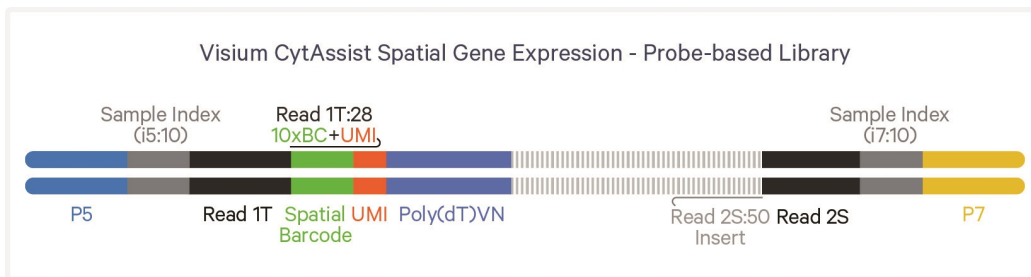

See [Oligonucleotide Sequences on page 122](#)

Tips & Best Practices



Icons



Tips & Best Practices section includes additional guidance



Signifies critical step requiring accurate execution



Troubleshooting section includes additional guidance



Indicates a version specific update in volume, temperature, instruction, etc.

General Reagent Handling

- Fully thaw and thoroughly mix reagents before use.
- When pipette mixing reagents, unless otherwise specified, set pipette to 75% of total volume.

Pipette Calibration

- Follow manufacturer's calibration and maintenance schedules.
- Pipette accuracy is particularly important when using SPRiselect reagents.

Visium Slide Storage

- Do not open the mylar bag containing the Visium Spatial slides until slides are ready to be used.

Visium Spatial Slide Handling

- Always wear gloves when handling slides.
- Ensure that the active surface of a slide faces up and is never touched. The active surface is defined by a readable label.
- Minimize exposure of the slides to sources of particles and fibers.
- When pipetting reagent onto a slide, avoid generating bubbles.
- Time between adding Probe Release Mix onto spacers on the Visium CytAssist Spatial Gene Expression v2 Slide on the Visium CytAssist instrument and starting a run should not exceed **5 min**.

Tissue Slide Handling

- To ensure compatibility with the Visium CytAssist, tissue sections must be placed in specific areas on a blank slide. Validated slides, as well as appropriate tissue placement areas, are listed in the [CytAssist Validated Slides](#) section.

Visium CytAssist Tissue Slide Cassette

- The Visium CytAssist Tissue Slide Cassette is used to create wells on plain glass slides with tissue for reagent addition and removal. It is distinct from the Visium Cassette, which is used to encase Visium CytAssist Spatial Gene Expression Slides.
- The Visium CytAssist Tissue Slide Cassette is a single use item.
- Gaskets are used to create a sealed well around tissue. Gaskets are combined with the complimentary Visium CytAssist Tissue Slide Cassette components to create a complete Visium CytAssist Cassette.
- The appropriately sized Visium CytAssist Tissue Slide Cassette and Gasket will be provided with the Visium CytAssist Spatial Gene Expression Slide kits.
- Reagent mixes for 6.5 mm cassettes and 11 mm cassettes will be differentiated by representative icons next to each table.
- Reagent volumes for 6.5 mm cassettes and 11 mm cassettes will be differentiated by ■ and ▲ symbols respectively.
- Before assembling the Visium CytAssist Tissue Slide Cassette, determine the correct slide orientation with the Tissue Slide Loading Guide (CG000548)
- To ensure that the gasket surrounds the tissue area of interest, gaskets can be adjusted from top to bottom (see image below). 6.5 mm gaskets may also be adjusted from side to side.
- Tissue or area of interest should be centered within the gasket.
- Prior to assembly, inspect the moveable gasket to ensure that the gasket perimeter and corners are free of excess silicone. Excess silicone should be safely removed with forceps or a pipette tip.
- Assemble against a white background for easy tissue visualization during alignment.

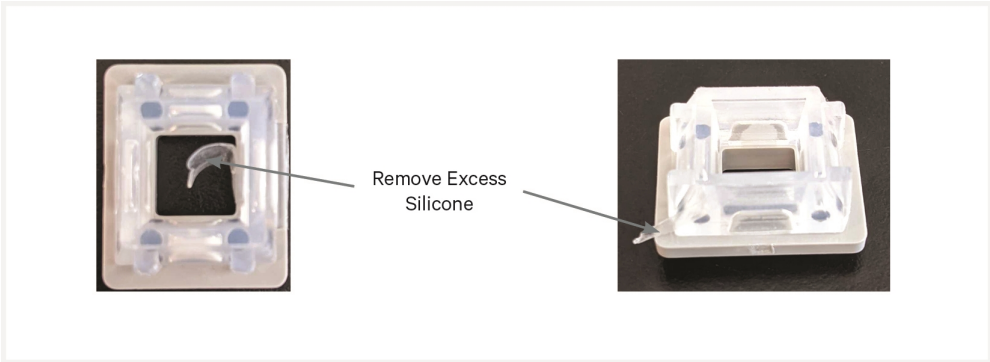
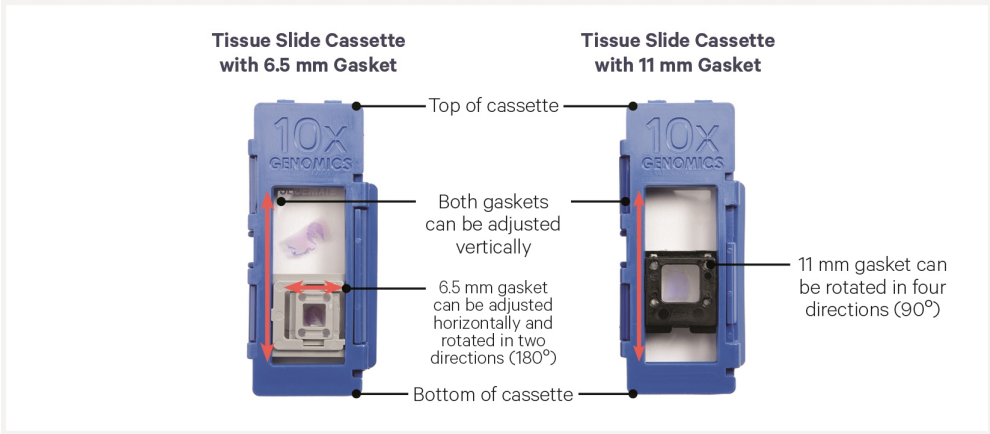

Visium CytAssist Tissue Slide Cassette Assembly

Assembly instructions apply to both Tissue Slide Cassette sizes.



Wear fresh gloves while assembling Tissue Slide Cassette



Exercise caution when handling slide edges to prevent injury.

Break cassette into two halves by bending each half at the hinge until they snap apart

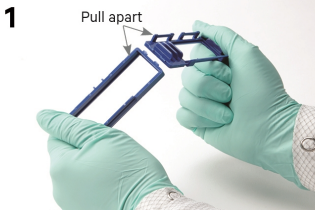

The 6.5 mm gasket can be adjusted horizontally and rotated in two directions (180°) while 11 mm gasket can be rotated in four directions (90°). Determine the appropriate configuration that allows the gasket to encompass the tissue region of interest.

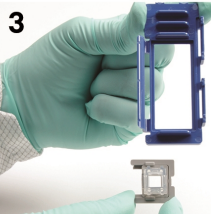

Gently place top half of cassette over bottom half. DO NOT assemble together until Step 6.

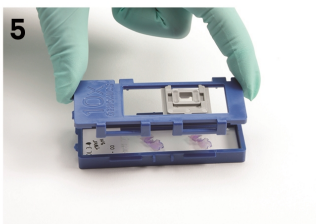

Apply even pressure on top of cassette until it clicks shut. Verify that clip is completely secured over hinges.

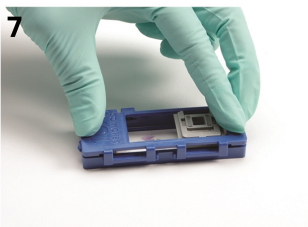

Place tissue slide into lower half of cassette with tissue facing up



Securely combine gasket with top half of cassette until the gasket snaps into place.

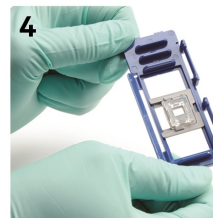

Adjust gasket such that gasket is over the tissue region of interest. The 6.5 mm gasket can be adjusted horizontally as well as vertically.

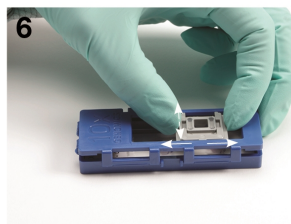

Turn cassette over and verify tissue region of interest is within gasket. DO NOT move gasket once cassette is closed. If necessary, open cassette and recenter gasket.

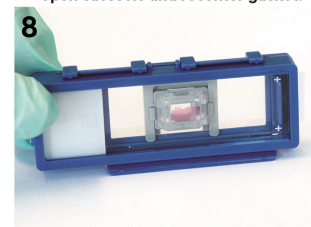

Visium CytAssist Tissue Slide Cassette Removal

Removal instructions apply to both Tissue Slide Cassette sizes.

Pull clip up to detach upper and lower halves of cassette

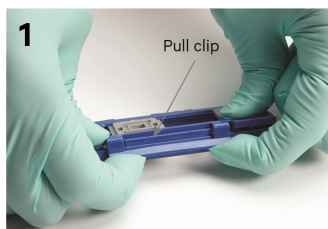

Open cassette by continuing to lift clip upward. If slide sticks to gasket, continue to apply even upward pressure to separate slide from gasket





Hold slide by the label and lift slide out from lower half

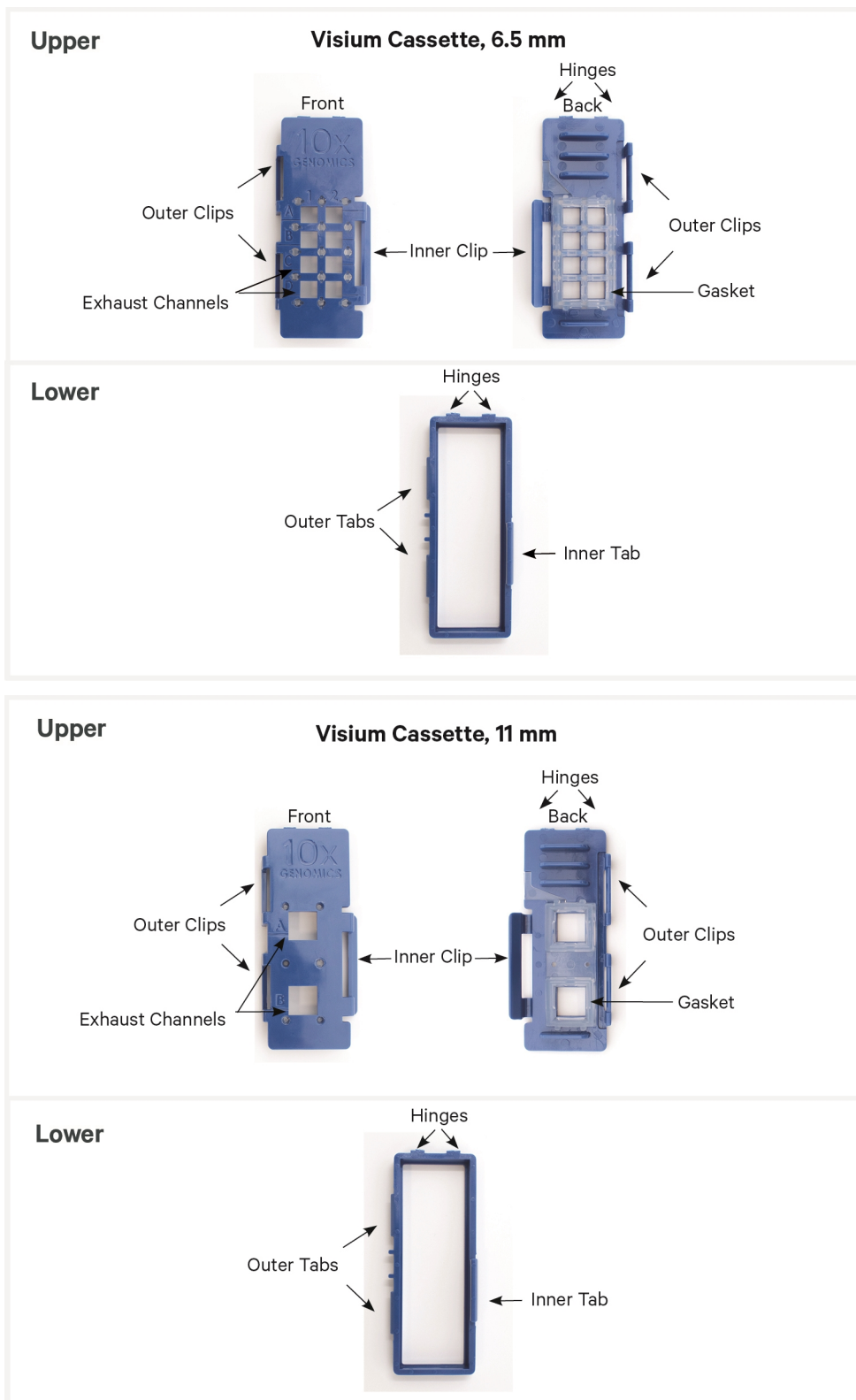

Slides in images are representative.

Visium Cassette



- The Visium Cassette encases the slide and creates leakproof wells for reagent addition.
- The Visium Cassette is a single use item.
- If using a Visium CytAssist 6.5 mm Slide, only wells A1 and D1 of the Visium Cassette are used. If necessary, circle A and D on the cassette with a permanent marker to serve as a reminder.
- Ensure that the Visium Cassette and gasket are free of debris prior to assembly. If placing the top half of the cassette on a surface, ensure the gasket faces away from the surface so it does not collect debris.
-  If the exhaust channels have raised pieces of silicone, these pieces are considered excess and must be removed. Run a 10 µl pipette tip through the exhaust channels to ensure they are clear. If excess silicone remains, remove with tweezers or a pipette tip.
- Failure to remove excess silicone may prevent adequate venting of the cassette during heated incubation steps.
- Visually inspect the gasket to ensure it is seated properly.
- If the gasket appears warped, the Visium Cassette is still safe to use as long as the cassette can fully close.

Remove Excess Silicone

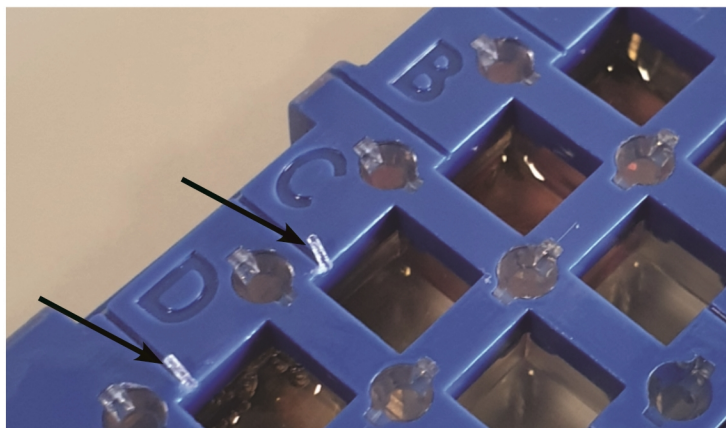

- See Visium Cassette Assembly & Removal instructions for details on assembly and removal.
- Practice assembly with a blank slide (75 x 25 x 1 mm).
- Place the slides in the Visium Cassette only when specified.
- Applying excessive force to the slide may cause the slide to break.

Visium Cassette Assembly

Ensure that the surface of the cassette is dry. Cassette may also be assembled in the hand for comfort.

DO NOT fold over upper and lower halves of cassette before detaching hinges.

Break cassette into two halves by bending each half at the hinge until they snap apart

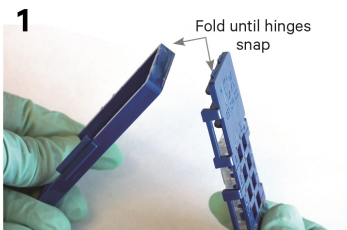

Place upper and lower halves of cassette, and Visium slide, directed upward on bench

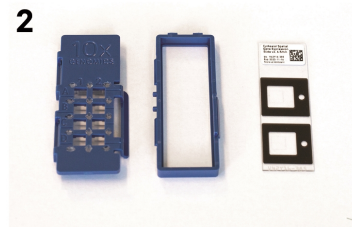

Place Visium slide with active surface facing upwards into lower half of cassette; ensure label is toward hinges



Press slide down into grooves of the bottom half of the cassette until it sits firmly in place

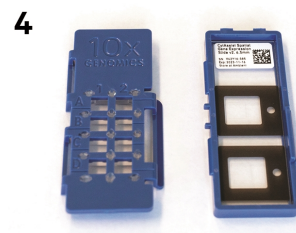

Secure outer clips of top half with outer tab of bottom half

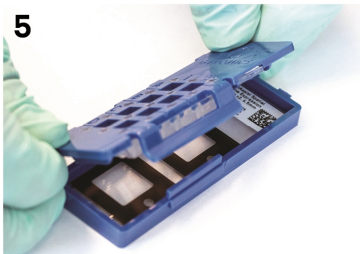

Press firmly on top of cassette until it clicks shut

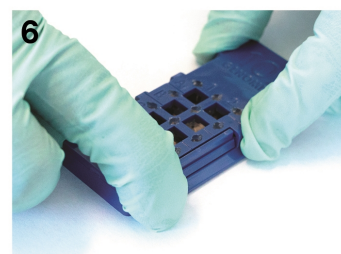

Exercise caution when handling slide edges to prevent injury.

Slides in images are representative.

Visium Cassette Removal



Assembly and removal steps apply to both 6.5 and 11 mm Cassettes.

Pull inner clip up from inner tab to detach upper and lower halves of cassette

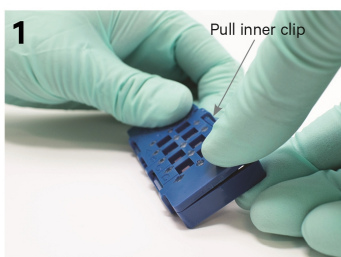

Open cassette by continuing to lift upper half upward

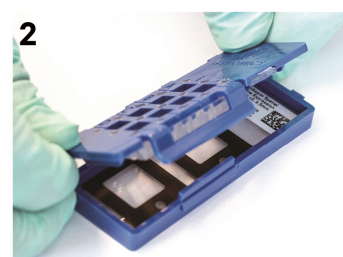

Lift slide out from lower half



Slides in images are representative.

Reagent Addition to Wells

- Assemble slide into the cassette flat on a clean work surface.
- Dispense and remove reagents along the side of the wells without touching the slide surface, tissue sections (when applicable), and without introducing bubbles.



- Always cover the Capture Area or tissue completely when adding reagents to the well. A gentle tap may help spread the reagent more evenly.

Reagent Addition/Removal

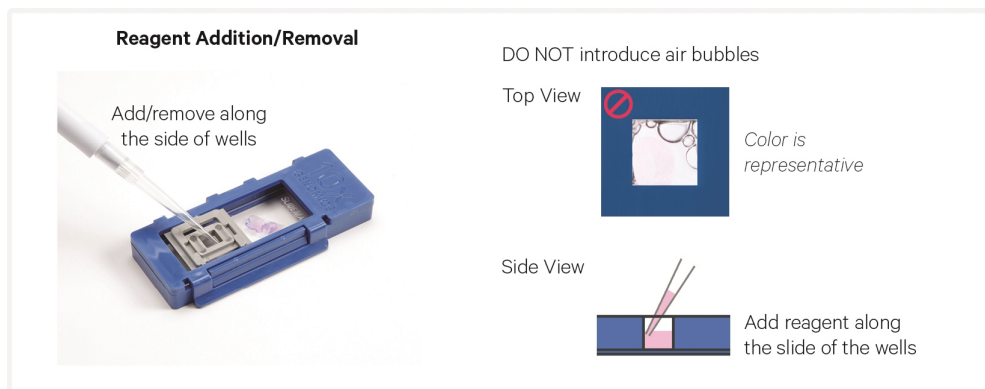

Reagent Removal from Wells

- Assemble slide into the cassette flat on a clean work surface.
- Slightly tilt the cassette while removing the reagent.
- Place the pipette tip on the bottom edge of the wells.
- Remove reagents along the side of the wells without touching the tissue sections (when applicable) and without introducing bubbles.
- Remove all liquid from the wells in each step. To ensure complete removal, check the bottom of the well by tilting the cassette slightly. A meniscus at the bottom of the well will indicate the presence of liquid in the well. Repeat removal steps until no reagent remains.



Visium Slide Seal Application & Removal

Application

- If applying a Visium Slide Seal to a Visium CytAssist Tissue Slide Cassette, the seal must be cut in half lengthwise. Cut the seal as shown in the image below. Three pre-cut seals are necessary for this assay.

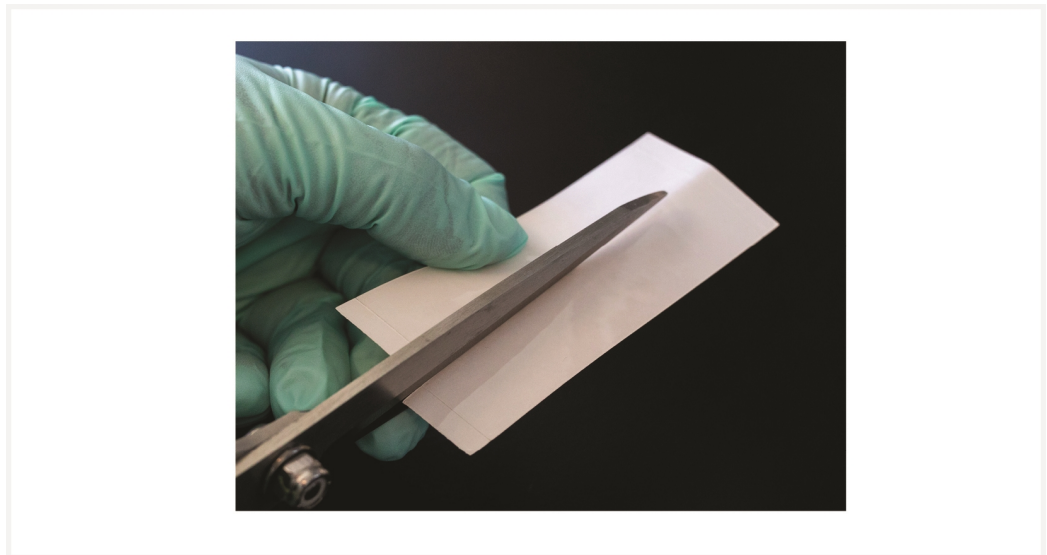

- Place the cassette flat on a clean work surface. Ensure surface of cassette is dry.
- Remove the back of the adhesive Visium Slide Seal.
- Align the Visium Slide Seal with the surface of the cassette and apply while firmly holding the cassette with one hand.
- Press on the Visium Slide Seal to ensure uniform adhesion.
- Use a fresh Visium Slide Seal when prompted during the protocol. Steps that do not require a new slide seal will specify that the slide seal should be pulled back and re-applied instead.

Apply Visium Slide Seal

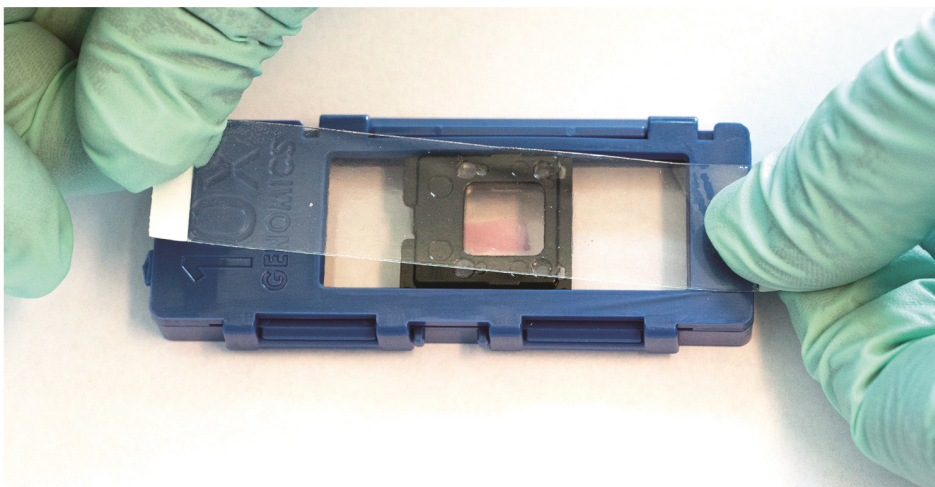

Removal

- Place the cassette flat on a clean work surface.
- Carefully pull on the Visium Slide Seal from the edge while firmly holding the cassette. Ensure that no liquid splashes out of the wells.

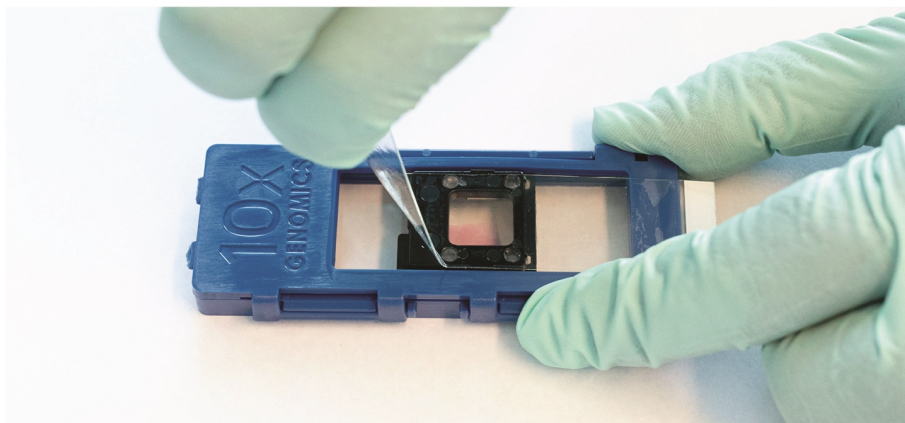

Slide Incubation Guidance

Incubation at a specified temperature

- Position a Low Profile Thermocycler Adapter on a thermal cycler that is set at the incubation temperature.
- Ensure that the Low Profile Thermocycler Adapter is in contact with the thermal cycler block surface uniformly. Pre-equilibrate adapters at the HOLD temperature described in the protocol steps for at least five minutes.
- When incubating a slide encased in a cassette, place the assembled unit on the Low Profile Thermocycler Adapter with the wells facing up. Ensure the cassette is in complete contact with the adapter. The cassette should always be sealed when on the Low Profile Thermocycler Adapter.

Incubate Assembled Visium Cassette

- Open and close the thermal cycler lid gently. If the lid is adjustable, tighten lid only as much as necessary. Avoid over-tightening. Image below is for demonstration purposes - thermal cycler lid should be closed when incubating the cassette.

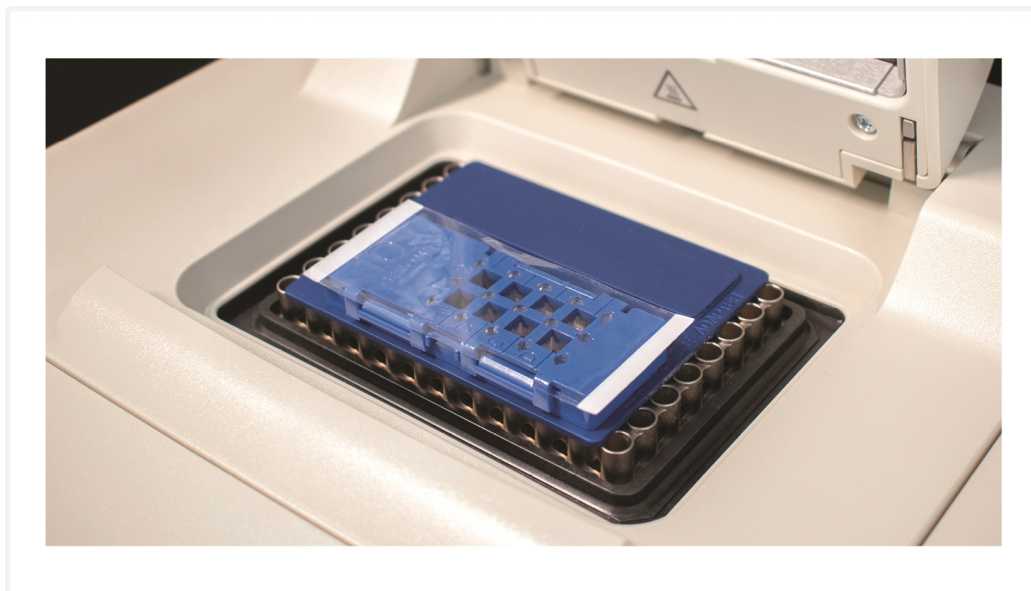

Incubation at room temperature

- Place the slide/cassette on a flat, clean, non-absorbent work surface.

Tissue Detachment on Tissue Slides



- Monitor section adhesion on tissue slides throughout the workflow.
- Ensure that tissue sections are on Superfrost or positively charged slides. A list of tested slides can be found in [Visium CytAssist Tested Slides on page 48](#).
- Tissue detachment prior to the completion of Probe Release during the workflow can negatively impact performance. If observed, contact support@10xgenomics.com.
- For more information, consult [Troubleshooting on page 102](#).

10x Magnetic Separator

- Offers two positions of the magnets (high and low) relative to a tube, depending on its orientation. Flip the magnetic separator over to switch between high (magnet•**High**) or low (magnet•**Low**) positions.



- If using MicroAmp 8-Tube Strips, use the high position (magnet•**High**) only throughout the protocol.

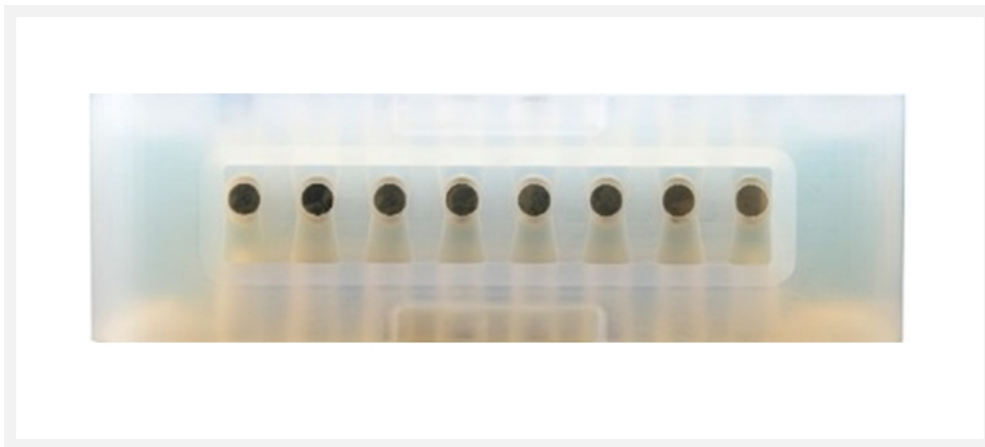

Magnetic Bead Cleanup Steps

- During magnetic bead based cleanup steps that specify waiting “until the solution clears”, visually confirm clearing of solution before proceeding to the next step. See panel below for an example. If solution is not clear, leave on magnet until separation is complete.
- The time needed for the solution to clear may vary based on specific step, reagents, volume of reagents, etc.

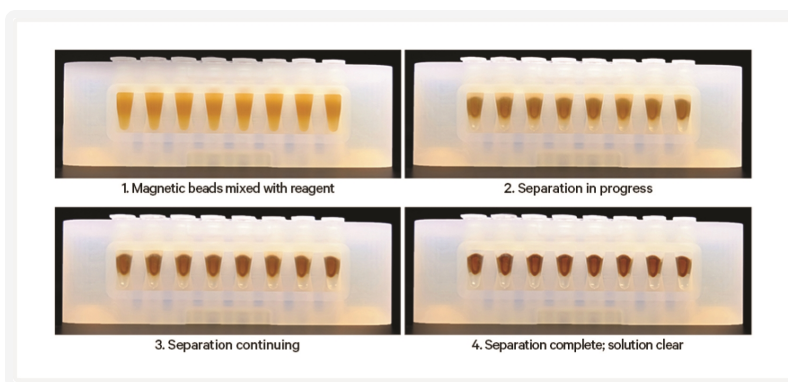

SPRIselect Cleanup & Size Selection

- After aspirating the desired volume of SPRIselect reagent, examine the pipette tips before dispensing to ensure the correct volume is transferred.
- Pipette mix thoroughly as insufficient mixing of sample and SPRIselect reagent will lead to inconsistent results.
- Use fresh preparations of 80% Ethanol.

Sample Indices (i5/i7) in Sample Index PCR

- Choose the appropriate sample index sets to ensure that no sample indices overlap in a multiplexed sequencing run.
- Each well in the Dual Index Plate TS Set A contains a unique i7 and a unique i5 oligonucleotide.
- To avoid the risk of cross-contamination, use each plate well once.

Visium CytAssist

Instrument Orientation	47
Visium CytAssist Tested Slides	48
CytAssist Loading Guidelines	49

Instrument Orientation

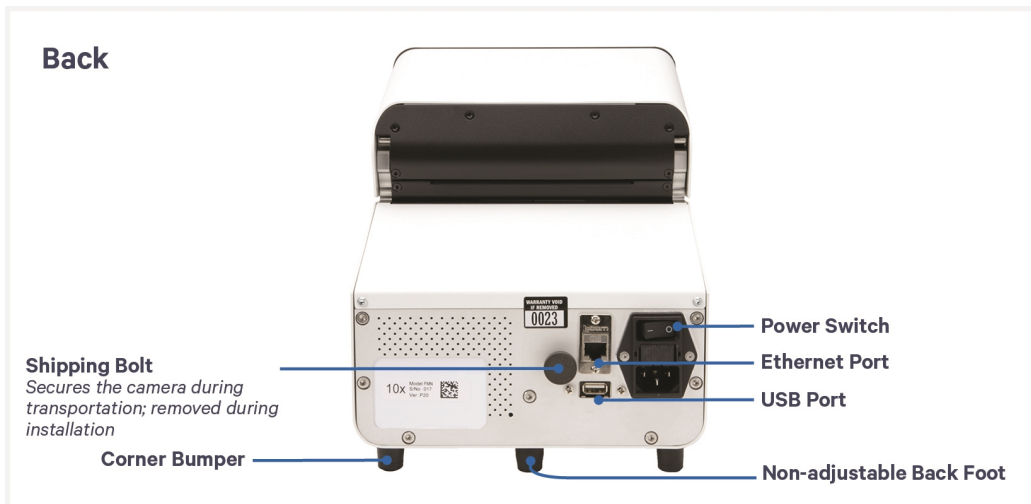
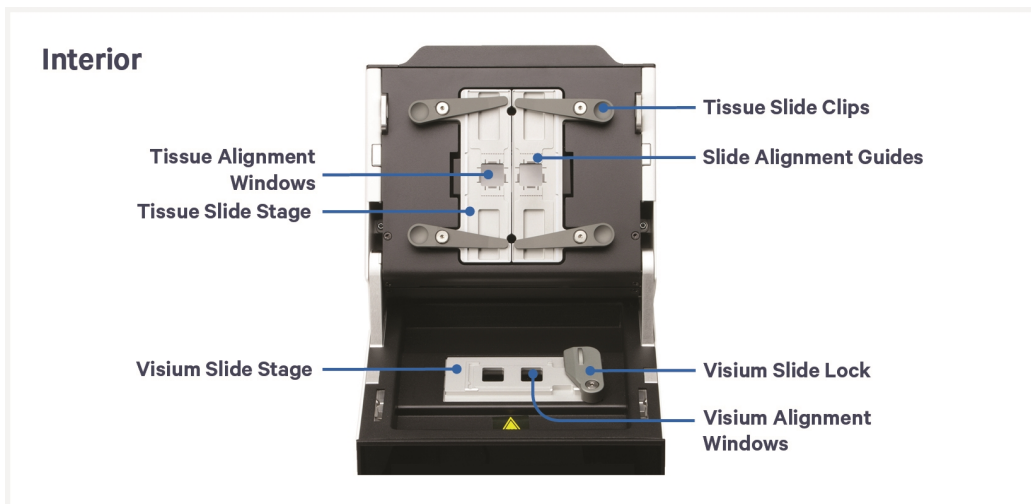

Visium CytAssist Tested Slides

The following slides have been tested for use with the Visium CytAssist instrument.

Item	Length (mm)	Width (mm)	Thickness (mm)	Ground Corners
EpreDia Shandon ColorFrost Plus	75.0	25.0	1.0	No
Fisherbrand SuperFrost Plus	75.0	25.0	1.0	Available as either
Sigma-Aldrich Poly Prep Slides	75.0	25.0	1.0	No
VWR SuperFrost Plus Micro Slide, Premium	75.0	25.0	1.0	No

If unsure of slide part number, refer to the diagram below for guidance. Diagrams for verifying that tissue sections are placed in the allowable area can also be found in the Visium CytAssist Quick Reference Cards - Accessory Kit (Document CG000548).

While slides are specified as being 25 x 75 mm, manufacturing tolerances may lead to dimensions that are incompatible with 10x Genomics products. Slide dimensions must be within 24.8 mm - 25.3 mm (width) and 74.4 mm - 76.2 mm (length) to fit the Visium CytAssist Tissue Slide Cassette. Minimum slide dimensions: 24.8 x 74.4 mm. Maximum slide dimensions: 25.3 x 76.2 mm.

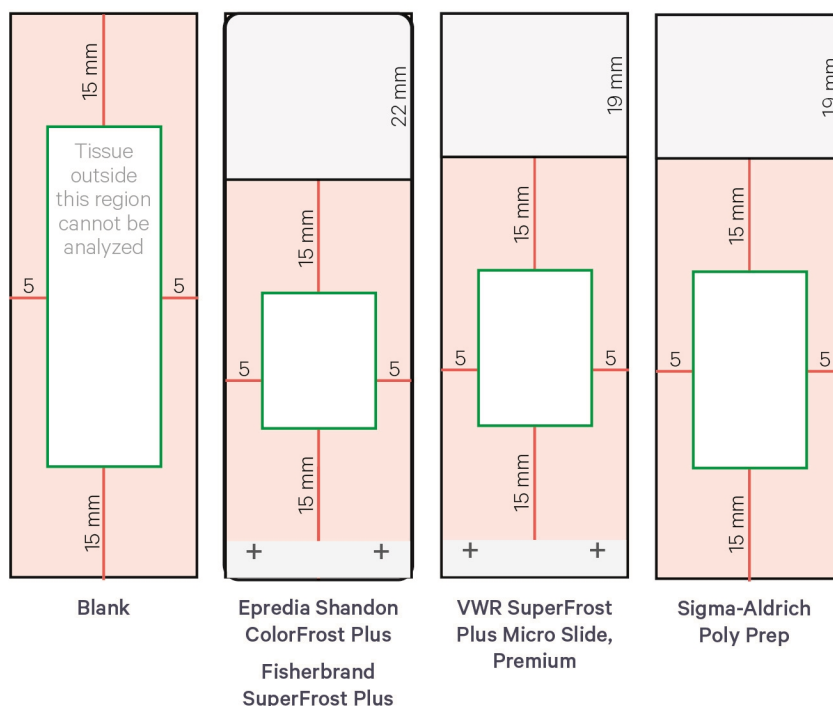

CytAssist Loading Guidelines

- Ensure tissue slide is compatible with Visium CytAssist by using the CytAssist Tissue Area Check Guide (CG0000548). A list of validated slide types and allowable tissue areas can be found in the CytAssist Validated Slides section.
- Each tissue slide may be used for one Capture Area on a Visium CytAssist Gene Expression v2 Slide.

Tissue Slide Loading

- Ensure the tissue on each slide fits within the allowable area of the Tissue Slide Stage.
- Align tissue within the center of the 6.5 mm slide alignment guides (rectangles) or the 11 mm slide alignment guides (lines) on either the left or right side of the stage.

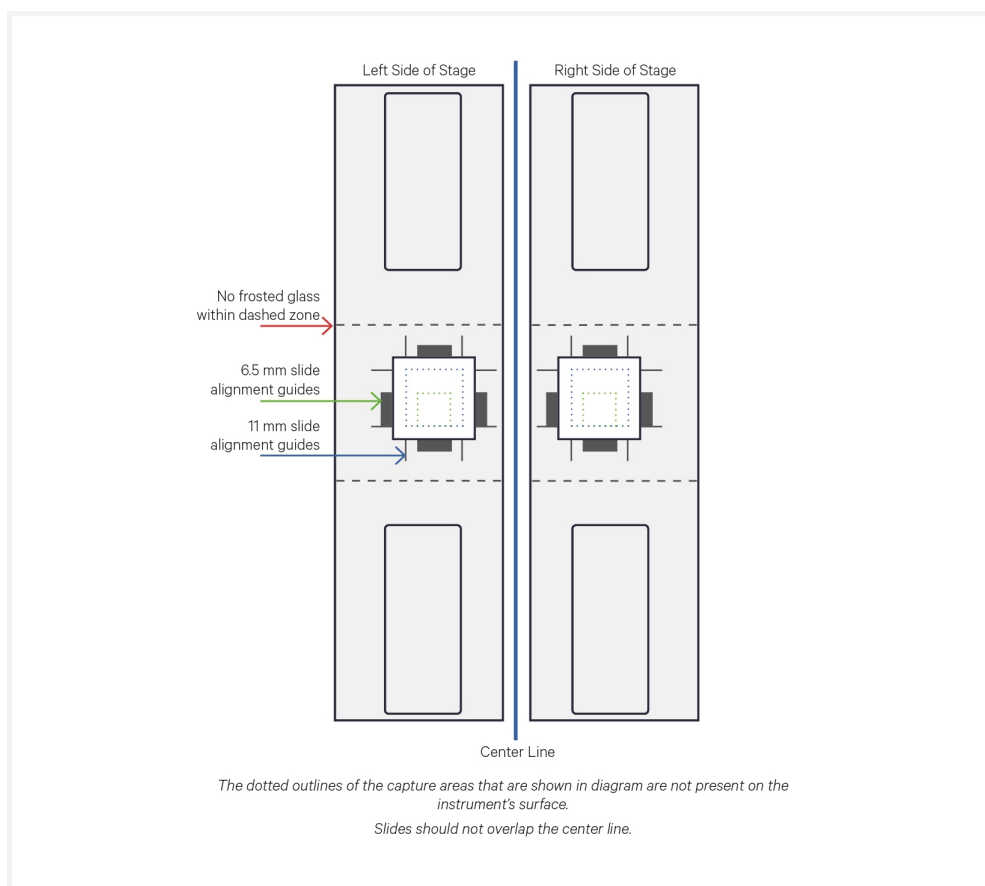

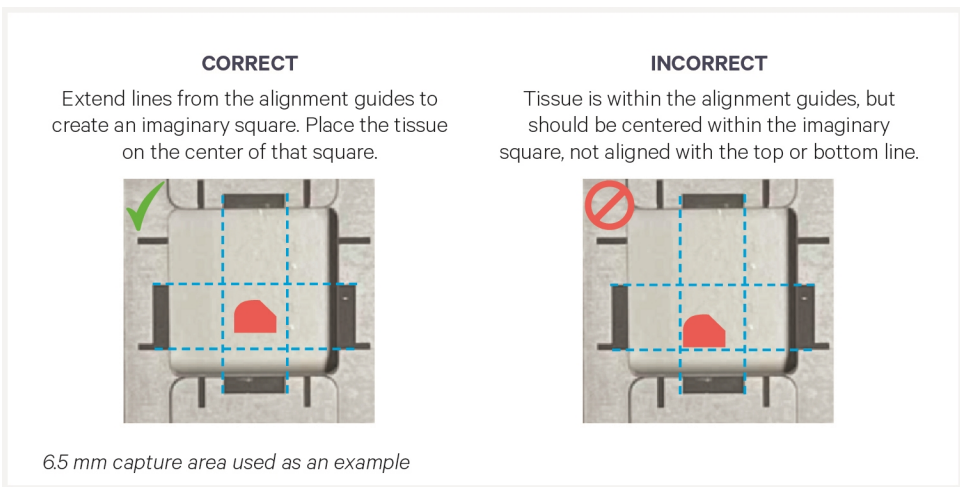

- c. If necessary, rotate the slide 180° as shown. Place off-center tissues closer to the center line. Slides should not overlap the center line.

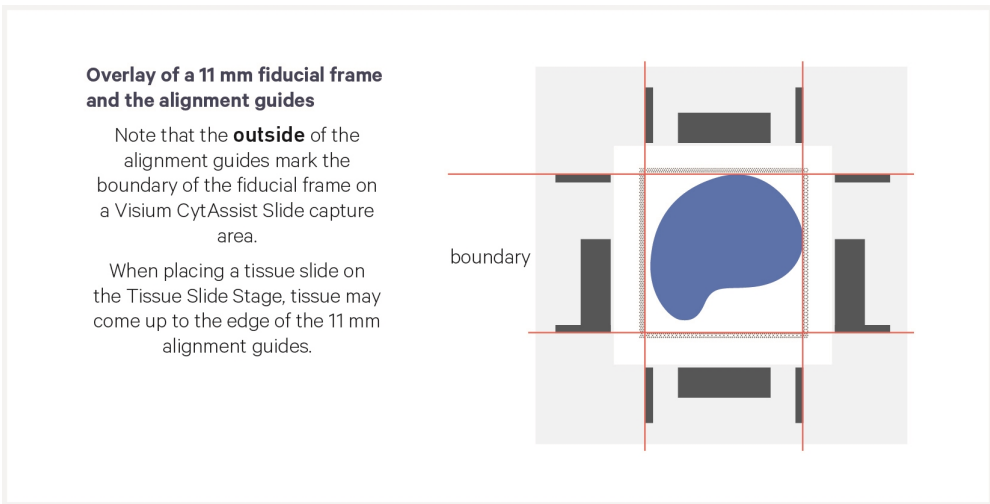
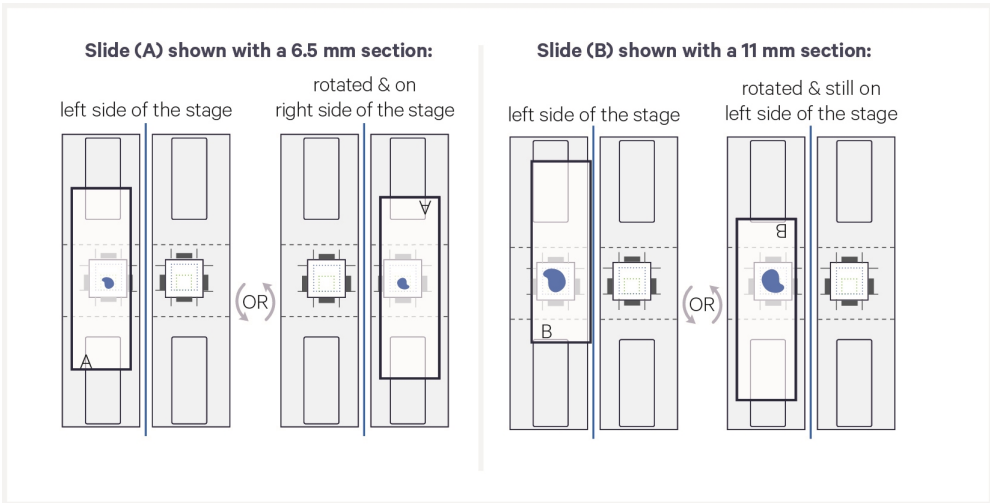

The image below demonstrates how movement of the Tissue Slides affects where target molecules will end up on the Visium Slide.

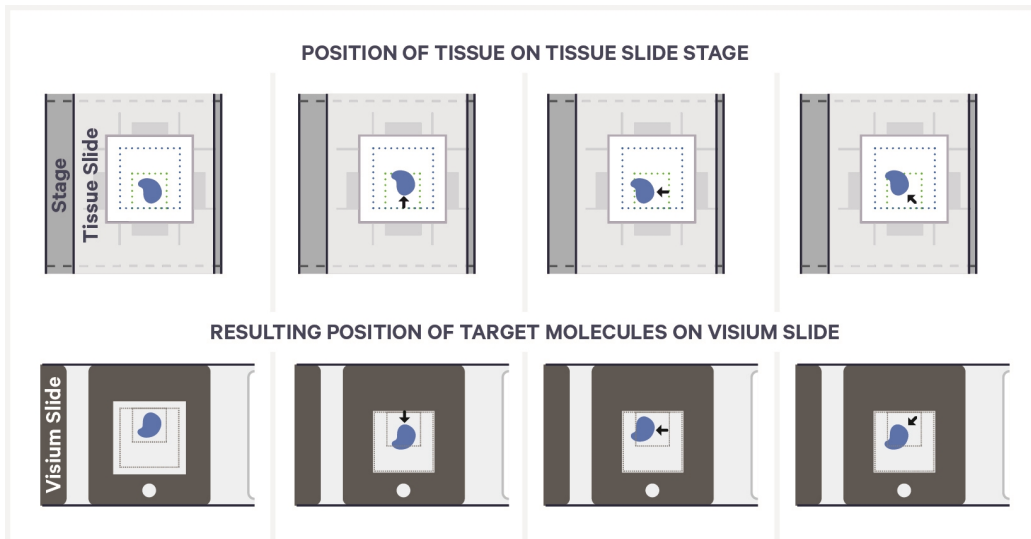

- d.** Press down on the wide end of clip to lift and pivot the narrow end of the clip. Pivot the clips to their outermost position.



- e.** Lay the tissue slide flat against the stage surface. Both hands needed: use one hand to hold the slide in place and the other to pivot the clips and overlap the slide. Ensure that at least one clip secures the slide before adjusting the position further.
- f.** Use fingers to finely adjust the position of the tissue within the alignment guides.

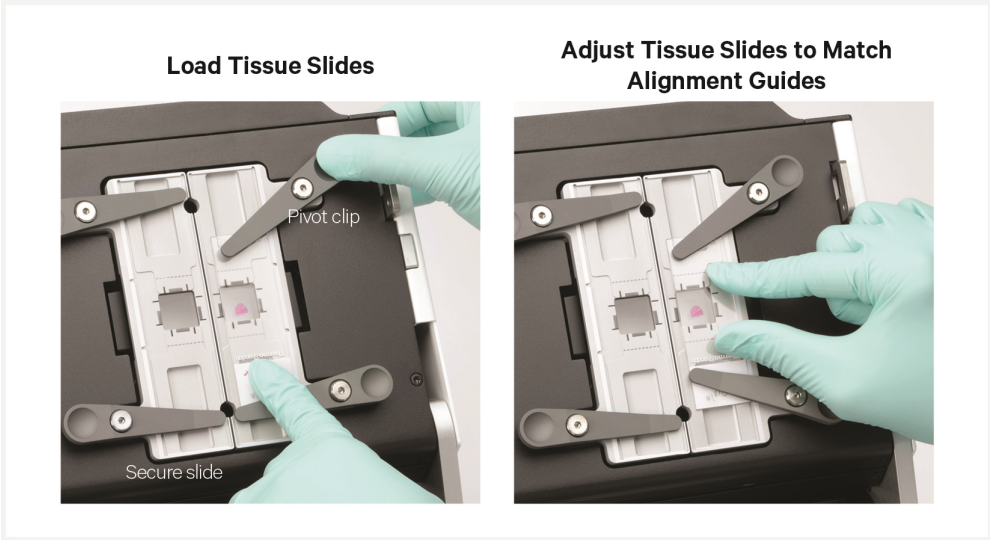

g. If only one tissue on one slide will be analyzed, use a blank slide for the second position on the Tissue Slide Stage.

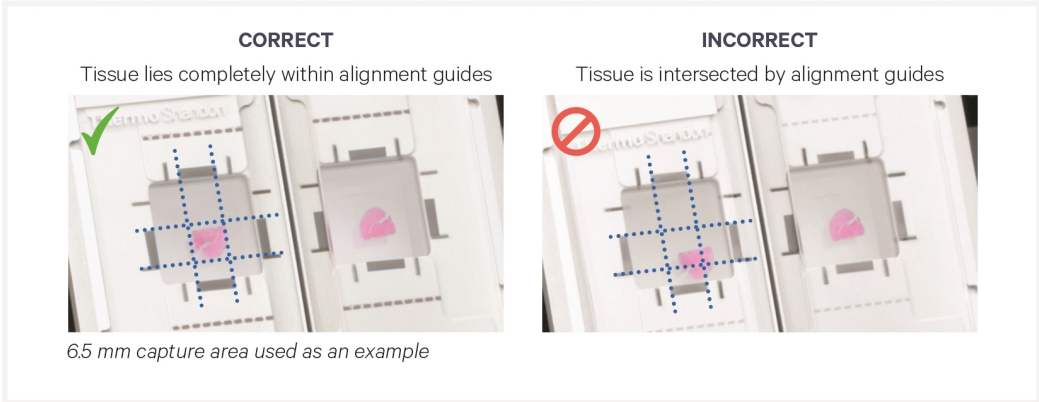
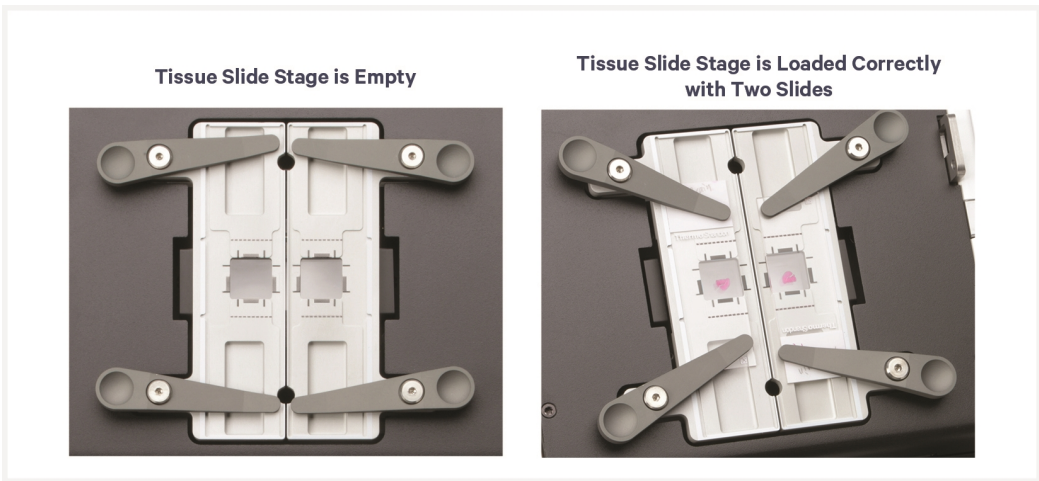

Visium CytAssist Spatial Slide Loading

Prior to loading, record the slide serial number and note which tissue is placed in which Capture Area.

- a. Open the Visium Slide Lock by using one finger to pivot.
- b. Line up the slide with the label face up and oriented to the right.
- c. Fit the slide within the raised grooves on the left, top and bottom.

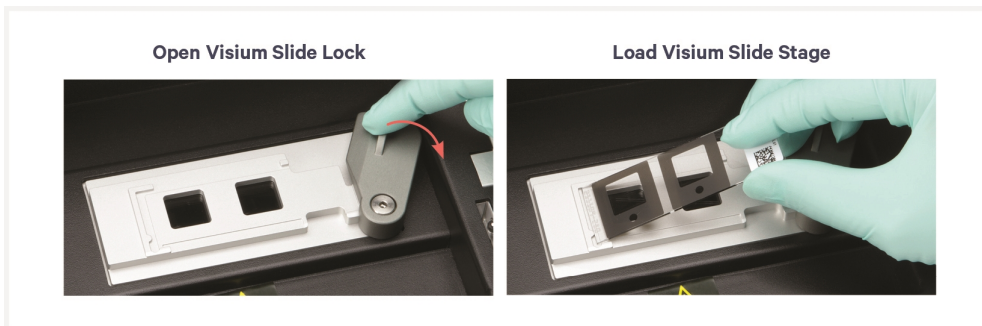

- d. Hold the slide in place with one hand while slowly closing the Visium Slide Lock. The lock will partially obscure the slide label when correctly secured.

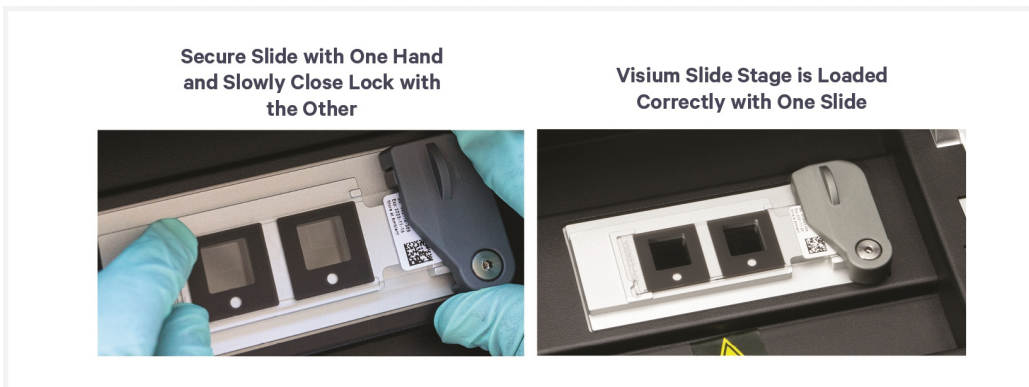

CORRECT

Slide fits inside the grooves.
Label on the right is partially obscured by the lock.
Capture areas line up with alignment windows.

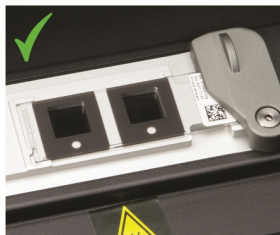

INCORRECT

Slide does not fit inside the grooves.
Capture areas do not line up with alignment windows.



INCORRECT

Label is on the left.
Capture areas do not line up with alignment windows.



Sample Preparation & Staining Guidelines

Sample Preparation

Proper tissue handling and preparation techniques preserve the morphological quality of the tissue sections and the integrity of mRNA transcripts. Maintaining high quality RNA is critical to assay performance.

Prior to performing the protocol steps in this User Guide, ensure that all samples have followed the appropriate Tissue Preparation protocols as described in the [Workflow Overview on page 19](#). Listed below are key considerations described in these tissue preparation protocols.

Key Considerations for FFPE Samples

FFPE Tissue Sectioning & Section Placement

- Assess RNA quality of the FFPE tissue block or from archived sections.
- Practice sectioning and section placement with a non-experimental block prior to placing sections on slides.
- Section the tissue block and place sections on compatible blank slides using a water bath.
- Place tissue sections on the allowable area on the slide. Allowable area may vary depending on slide choice. Refer to [CytAssist Tested Slides](#) for more information.

Slide Handling (after tissue placement)

- Store the slides containing FFPE sections for up to two weeks in a desiccator at room temperature.

Key Considerations for FF Samples

Freezing and Embedding

- Snap freeze samples in a bath of isopentane and liquid nitrogen.
- Embed frozen samples in OCT.
- Store frozen samples in a sealed container at -80°C for long-term storage.

Slide Handling (before tissue placement)

- Equilibrate slides to cryostat temperature before cryosectioning.

Cryosectioning

- Assess RNA quality of the tissue block.
- Practice sectioning and section placement with a non-experimental block prior to placing sections on slides.
- Equilibrate OCT tissue block to the cryostat chamber temperature for 30 min.

Key Considerations for FF Samples (continued)

Section the tissue block and place sections on compatible blank slides.

Slide Handling (after tissue placement)

Maintain slides containing sections in a low moisture environment.

Keep slides cold and transport slides on dry ice.

Store tissue slides in a slide mailer at -80°C for up to two months.

Key Considerations for FxF Samples

Fixation, Embedding, and Freezing

Fix samples in 4% PFA.

Cryopreserve samples in a sucrose gradient.

Embed fixed samples in OCT and freeze.

Sample Block Storage

Store frozen samples in a sealed container at -80°C for long-term storage.

Slide Handling (before tissue placement)

Equilibrate slides to cryostat temperature before cryosectioning.

Cryosectioning

Assess RNA quality of the tissue block.

Practice sectioning and section placement with a non-experimental block prior to placing sections on slides.

Equilibrate OCT tissue block to the cryostat chamber temperature for 30 min.

Section the tissue block and place sections on compatible blank slides.

Slide Handling (after tissue placement)

Maintain slides containing sections in a low moisture environment.

Keep slides cold and transport slides on dry ice.

Store tissue slides in a slide mailer at -80°C for up to two months.

Step 1:

Probe Hybridization

1.0 Get Started	58
1.1 Probe Hybridization	59

1

1.0 Get Started

Each 10x Genomics reagent tube is good for two 6.5 mm slides or one 11 mm slide.

Items	10x PN	Preparation & Handling	Storage	
Equilibrate to room temperature				
<input type="checkbox"/>	FFPE Hyb Buffer	2000423	Thaw at room temperature. If precipitate persists, heat at 37°C until dissolved. Avoid vortexing to prevent bubble formation. Pipette mix 10x. Keep the buffer at room temperature after thawing and while performing the workflow, then return to -20°C when finished	-20°C
Place on ice				
<input type="checkbox"/>	Human WT Probes v2 - RHS	2000657	Thaw on ice. Vortex and centrifuge briefly.	-20°C
<input type="checkbox"/>	Human WT Probes v2 - LHS	2000658	Thaw on ice. Vortex and centrifuge briefly.	-20°C
<input type="checkbox"/>	Mouse WT Probes - RHS	2000455	Thaw on ice. Vortex and centrifuge briefly.	-20°C
<input type="checkbox"/>	Mouse WT Probes - LHS	2000456	Thaw on ice. Vortex and centrifuge briefly.	-20°C
Obtain				
<input type="checkbox"/>	Nuclease-free Water	-	-	Ambient
<input type="checkbox"/>	10X PBS, pH 7.4	-	-	Ambient
<input type="checkbox"/>	Visium CytAssist Tissue Slide Cassette, 6.5 or 11 mm Gasket	1000519/ 1000520 1000471/ 1000472	See Tips & Best Practices.	Ambient
<input type="checkbox"/>	Visium Slide Seals	2000284	See Tips & Best Practices. 3 pre-cut slide seals are necessary for the complete workflow.	Ambient
<input type="checkbox"/>	10% Tween-20	-	-	Ambient

1.1 Probe Hybridization



Before starting this protocol, ensure that tissue sections have been stained according to the appropriate protocol. Refer to [Workflow Overview on page 19](#) for more information.



During reagent removal steps, ensure that **ALL the liquid is removed** from the wells. See Tips & Best Practices for guidance on Reagent Removal.

■ denotes volumes for 6.5 mm gaskets and ▲ denotes volumes for 11 mm gaskets.

- a. Prepare Pre-Hybridization Mix according to the appropriate table shortly before use. Add reagents in the order listed. Maintain at **room temperature**. Vortex and centrifuge briefly.



6.5 mm Gaskets				
Pre-Hybridization Mix	10x PN	1X (μl)	2X +10% (μl)	4X +10% (μl)
Nuclease-free Water	-	89.5	196.9	393.8
10X PBS, pH 7.4	-	10.0	22.0	44.0
10% Tween-20	-	0.5	1.1	2.2
Total	-	100.0	220.0	440.0



11 mm Gaskets				
Pre-Hybridization Mix	10x PN	1X (μl)	2X +10% (μl)	4X +10% (μl)
Nuclease-free Water	-	179.0	393.8	787.6
10X PBS, pH 7.4	-	20.0	44.0	88.0
10% Tween-20	-	1.0	2.2	4.4
Total	-	200.0	440.0	880.0

- b. Retrieve Tissue Slide Cassette containing H&E stained or IF stained sections.
- c. Peel back Visium Slide Seal.
- d. Using a pipette, remove all buffer from well corners.
- e. Add ■ **100 μl** or ▲ **200 μl** Pre-Hybridization Mix along the side of the wells to uniformly cover the tissue sections, without introducing bubbles.
- f. Re-apply Visium Slide Seal on the Tissue Slide Cassette.

g. Incubate for 15 min at room temperature.



h. Prepare a thermal cycler with the following incubation protocol and start the program.

Lid Temperature	Reaction Volume	Run Time
50°C	100 µl	Overnight (16 - 24 h)
Step	Temperature	Time hh:mm:ss
Pre-equilibrate	50°C	Hold
Hybridization	50°C	Overnight (16 - 24 h)
Post Hybridization Wash	50°C	Hold

- j. Prepare Probe Hybridization Mix according to the appropriate table shortly before use. Add reagents in the order listed. Keep at **room temperature**. Pipette mix 10x and centrifuge briefly.



6.5 mm Gaskets				
Probe Hybridization Mix	10x PN	1X (µl)	2X +10% (µl)	4X +10% (µl)
Nuclease-free Water	-	10.0	22.0	44.0
FFPE Hyb Buffer	2000423	70.0	154.0	308.0
● Human WT Probes v2 - RHS or Mouse WT Probes - RHS	2000657 or 2000455	10.0	22.0	44.0
● Human WT Probes v2 - LHS or Mouse WT Probes - LHS	2000658 or 2000456	10.0	22.0	44.0
Total	-	100.0	220.0	440.0



11 mm Gaskets				
Probe Hybridization Mix	10x PN	1X (µl)	2X +10% (µl)	4X +10% (µl)
Nuclease-free Water	-	19.9	43.8	87.6
FFPE Hyb Buffer	2000423	140.1	308.2	616.4
● Human WT Probes v2 - RHS or Mouse WT Probes - RHS	2000657 or 2000455	20.0	44.0	88.0
● Human WT Probes v2 - LHS or Mouse WT Probes - LHS	2000658 or 2000456	20.0	44.0	88.0
Total	-	200.0	440.0	880.00

- k. Remove Visium Slide Seal from the Tissue Slide Cassette.
 - 1. Remove all Pre-Hybridization Mix from the wells.
- m. Add ■ 100 µl or ▲ 200 µl room temperature Probe Hybridization Mix to each well.
- n. Apply a new pre-cut Visium Slide Seal on the Tissue Slide Cassette and place on the Low Profile Thermocycler Adapter on the thermal cycler. Close the thermal cycler lid.

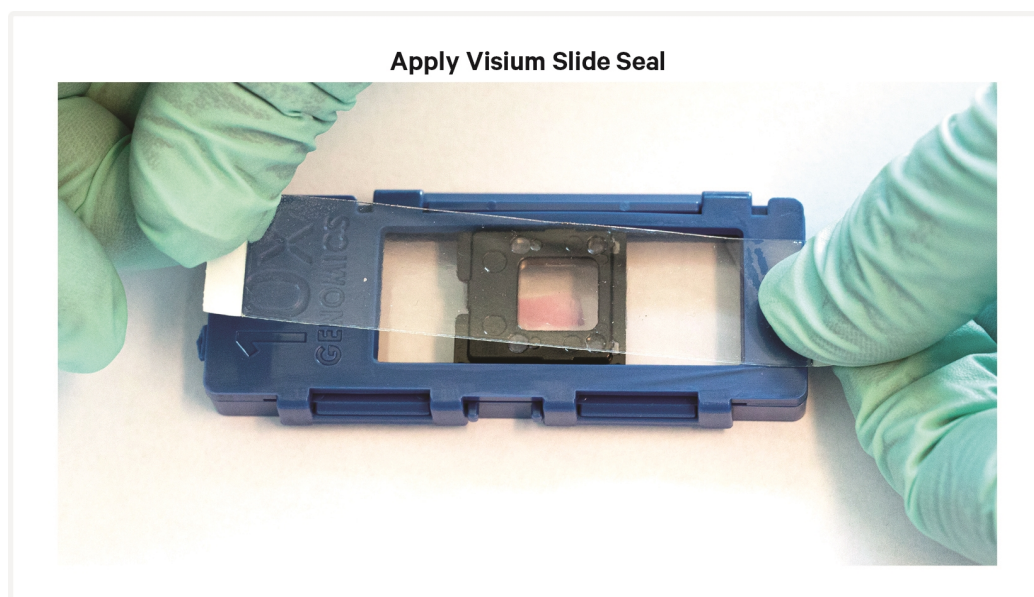

- Skip Pre-equilibrate step to initiate Hybridization.

Step 2:

Probe Ligation

2.0 Get Started	64
2.1 Post-Hybridization Wash	65
2.2 Probe Ligation	67
2.3 Post-Ligation Wash	69

2

2.0 Get Started

Each 10x Genomics reagent tube is good for two 6.5 mm slides or one 11 mm slide.

Items	10x PN	Preparation & Handling	Storage	
Equilibrate to room temperature				
<input type="checkbox"/>	FFPE Post-Hyb Wash Buffer	2000424	Thaw at room temperature. If precipitate persists, heat at 37°C until dissolved. Vortex briefly. Flick tube until liquid settles at the bottom of the tube.	-20°C
<input type="checkbox"/>	2X Probe Ligation Buffer	2000445	Thaw at room temperature until no precipitate remains. Vortex and centrifuge briefly.	-20°C
<input type="checkbox"/>	Post-Ligation Wash Buffer	2000419	Thaw at room temperature. If precipitate persists, heat at 37°C until dissolved. Vortex and centrifuge briefly.	-20°C
Place on ice				
<input type="checkbox"/>	Probe Ligation Enzyme	2000425	Centrifuge briefly. Maintain on ice.	-20°C
Obtain				
<input type="checkbox"/>	Nuclease-free Water	-	-	Ambient
<input type="checkbox"/>	20X SSC	-	-	Ambient

2.1 Post-Hybridization Wash

■ denotes volumes for 6.5 mm gaskets and ▲ denotes volumes for 11 mm gaskets.

- a. Aliquot FFPE Post-Hyb Wash Buffer (**495 µl/per 6.5 mm sample, 990 µl/per 11 mm sample**) and pre-heat to **50°C**.
- b. Prepare 2X SSC Buffer according to the appropriate table. Add reagents in the order listed. Maintain at **room temperature**. DO NOT discard excess buffer, as it will be used for subsequent washes in the protocol.



6.5 mm Gaskets					
SSC Buffer	Stock	Final	1X (µl)	2X +10% (µl)	4X +10% (µl)
SSC	20X	2X	355	781	1,562
Nuclease-free Water	-	-	3,195	7,029	14,058
Total	-	-	3,550*	7,810*	15,620*





11 mm Gaskets					
SSC Buffer	Stock	Final	1X (µl)	2X +10% (µl)	4X +10% (µl)
SSC	20X	2X	410	902	1,804
Nuclease-free Water	-	-	3,690	8,118	16,236
Total	-	-	4,100*	9,020*	18,040*

*Volume of 2X SSC Buffer is sufficient for washes in all subsequent steps.

- c. Remove the Tissue Slide Cassettes from the Low Profile Thermocycler Adapter and place on a flat, clean work surface.
- d. Peel back Visium Slide Seal and using a pipette, remove all Probe Hybridization Mix from the well.
- e. **Immediately** add ■ **150 µl** or ▲ **300 µl** pre-heated FFPE Post-Hyb Wash Buffer to each well. Avoid well drying or cooling to room temperature. Removal and addition of buffers should be done quickly.
- f. Re-apply Visium Slide Seal on the Tissue Slide Cassette and place on the Low Profile Thermocycler Adapter on the pre-heated thermal cycler. Close thermal cycler lid.
- g. Skip the Hybridization step and initiate Post-Hybridization Wash. Incubate in the thermal cycler at **50°C** for **5 min**.



-  **h.** Remove the Tissue Slide Cassettes from the Low Profile Thermocycler Adapter and place on a flat, clean work surface. Exercise caution, as slide is very hot.
-  **i.** Peel back Visium Slide Seal and using a pipette, remove all FFPE Post-Hyb Wash Buffer from the wells.
-  **j. Immediately** add **■150 µl** or **▲300 µl** pre-heated FFPE Post-Hyb Wash Buffer to each well. Avoid well drying or cooling to room temperature. Removal and addition of buffers should be done quickly.
- k.** Re-apply Visium Slide Seal on the Tissue Slide Cassette and place on the Low Profile Thermocycler Adapter on the pre-heated thermal cycler. Close the thermal cycler lid.
 - l.** Incubate in the thermal cycler at **50°C** for **5 min.**
- m. Repeat** steps h-l one more time for a total of three washes.
- n.** Remove the Visium Slide Seal and remove FFPE Post-Hyb Wash Buffer.
- o.** Add **■ 150 µl** or **▲ 300 µl** 2X SSC Buffer to each well and re-apply seal.
- p.** Let the Tissue Slide Cassettes cool to **room temperature (~3 min)** before proceeding to the next step.

2.2 Probe Ligation

■ denotes volumes for 6.5 mm gaskets and ▲ denotes volumes for 11 mm gaskets.

- a. Place a Low Profile Thermocycler Adapter onto a thermal cycler (if not already placed), prepare with the following incubation protocol, and start the program.

Lid Temperature	Reaction Volume	Run Time
37°C (lid may be turned off if the instrument doesn't enable 37°C)	100 µl	1 h

Step	Temperature	Time hh:mm:ss
Pre-equilibrate	37°C	Hold
Ligation	37°C	01:00:00
Hold	4°C	Hold

- b. Prepare Probe Ligation Mix according to the appropriate table shortly before use. Add reagents in the order listed. Pipette mix 10x and centrifuge briefly. Maintain on ice.



6.5 mm Gaskets					
Probe Ligation Mix	10x PN	1X (µl)	2X +10% (µl)	4X +10% (µl)	
Nuclease-free Water	-	24.0	52.8	105.6	
○ 2X Probe Ligation Buffer	2000445	30.0	66.0	132.0	
○ Probe Ligation Enzyme	2000425	6.0	13.2	26.4	
Total	-	60.0	132.0	264.0	



11 mm Gaskets					
Probe Ligation Mix	10x PN	1X (µl)	2X +10% (µl)	4X +10% (µl)	
Nuclease-free Water	-	52.0	114.4	228.8	
○ 2X Probe Ligation Buffer	2000445	65.0	143.0	286.0	
○ Probe Ligation Enzyme	2000425	13.0	28.6	57.2	
Total	-	130.0	286.0	572.0	

- c. Remove all 2X SSC Buffer from the wells.
-  d. Add **60 μ l** or **130 μ l** Probe Ligation Mix directly to tissue sections, without introducing bubbles. Tap Tissue Slide Cassette gently to ensure uniform coverage.
- e. Apply a new pre-cut Visium Slide Seal on the Tissue Slide Cassette and place on the Low Profile Thermocycler Adapter on the pre-heated thermal cycler. Close the thermal cycler lid.
- f. Skip Pre-equilibrate step to initiate Ligation.

2.3 Post-Ligation Wash

■ denotes volumes for 6.5 mm gaskets and ▲ denotes volumes for 11 mm gaskets.



Use room temperature Post-Ligation Wash Buffer at the first wash step (step 2.3e). Use pre-heated Post-Ligation Wash Buffer at the second wash step (step 2.3j).

- a. Pre-heat Post-Ligation Wash Buffer (■ **110 µl/sample** or ▲ **220 µl/sample**) to **57°C**. Only **100 µl** per 6.5 mm sample or **200 µl** per 11 mm sample is needed.
- b. Remove the Tissue Slide Cassette from the Low Profile Thermocycler Adapter and place on a flat, clean work surface.
- c. Immediately prepare a thermal cycler with the following incubation protocol and start the program.

Lid Temperature	Reaction Volume	Run Time
57°C	100 µl	-
Step	Temperature	Time
Incubate	57°C	Hold

- d. Remove the Visium Slide Seal and using a pipette, remove all Probe Ligation Mix from all wells.



- e. Immediately add ■**100 µl** or ▲ **200 µl room temperature** Post-Ligation Wash Buffer to each well. Removal and addition of buffers should be done quickly.
- f. Apply a new pre-cut Visium Slide Seal on the Tissue Slide Cassette and place on the Low Profile Thermocycler Adapter on the pre-heated thermal cycler. Close the thermal cycler lid.
- g. Incubate at **57°C** for **5 min**.
- h. Remove the Tissue Slide Cassette from the Low Profile Thermocycler Adapter and place on a flat, clean work surface.
- i. Peel back the Visium Slide Seal and using a pipette, remove all Post-Ligation Wash Buffer.
- j. Add ■ **100 µl** or ▲ **200 µl pre-heated** Post-Ligation Wash Buffer to each well.
- k. Re-apply Visium Slide Seal on the Tissue Slide Cassette and place on the Low Profile Thermocycler Adapter on the pre-heated thermal cycler. Close

the thermal cycler lid.

- l.** Incubate at **57°C** for **5 min**.
- m.** Remove the Tissue Slide Cassette from the Low Profile Thermocycler Adapter and place on a flat, clean work surface.
- n.** Peel back the Visium Slide Seal and using a pipette, remove all Post Ligation Wash Buffer.
- o.** Add **■ 150 µl** or **▲ 300 µl** 2X SSC Buffer prepared at step 2.1b to each well.
- p.** Remove all 2X SSC Buffer
- q.** Add **■ 150 µl** or **▲ 300 µl** 2X SSC Buffer to each well.
- r.** Re-apply Visium Slide Seal on the Tissue Slide Cassette.
-  **s.** Store at **4°C** for up to **24 h** or allow to come to room temperature for **5 min** and proceed to next step.

Step 3:

Probe Release & Extension

3.0 Get Started	72
3.1 CytAssist Enabled RNA Digestion & Tissue Removal	73
3.2 Probe Extension	82
3.3 Probe Elution	83



3.0 Get Started

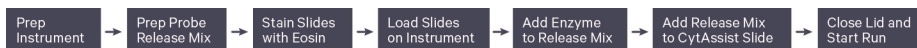

Each 10x Genomics reagent tube is good for two 6.5 mm slides or one 11 mm slide.

Items	10x PN	Preparation & Handling	Storage
Equilibrate to room temperature			
<input type="checkbox"/> ● RNase Buffer B	2000551	Thaw at room temperature. Pipette mix slowly and thoroughly with a wide-bore pipette. DO NOT vortex.	-20°C
<input type="checkbox"/> ● Extension Buffer	2000409	Thaw at room temperature, vortex, centrifuge briefly.	-20°C
<input type="checkbox"/> ● Tissue Removal Enzyme	3000387	Pipette mix, centrifuge briefly. Maintain at room temperature until ready to use.	-20°C
Place on ice			
<input type="checkbox"/> ● RNase Enzyme	3000593	Pipette mix, centrifuge briefly. Maintain on ice until ready to use.	-20°C
<input type="checkbox"/> ● Extension Enzyme	2000389	Pipette mix, centrifuge briefly. Maintain on ice until ready to use.	-20°C
Obtain			
<input type="checkbox"/>	Nuclease-free Water	-	Ambient
<input type="checkbox"/>	Wide-bore Pipette Tips	-	Ambient
<input type="checkbox"/>	Tris 1 M, pH 8.0 (Tris-HCl)	-	Manufacturer's recommendations. Ambient
<input type="checkbox"/>	Alcoholic Eosin	-	Manufacturer's recommendations. Ambient
<input type="checkbox"/>	1X PBS	-	Manufacturer's recommendations. Prepare 1X solution from stock with nuclease-free water. Ambient
<input type="checkbox"/>	2X SSC Buffer	-	Prepared at step 2.1b. Ambient
<input type="checkbox"/>	8 M KOH Solution	-	Manufacturer's recommendations. Ambient
<input type="checkbox"/>	Visium Cassette	3000811/ 3000812	See Tips & Best Practices. Ambient
<input type="checkbox"/>	Visium Slide Seals	2000284	See Tips & Best Practices. Ambient

3.1 CytAssist Enabled RNA Digestion & Tissue Removal

■ denotes volumes for 6.5 mm gaskets and ▲ denotes volumes for 11 mm gaskets.

If processing more than two tissue slides, keep remaining tissue slides at 4°C with 2X SSC buffer.

- a. Ensure that Visium CytAssist is powered on, clean, and ready for an experimental run.

The home screen is the most common state of the instrument. There are several key functions accessible directly from the home screen.

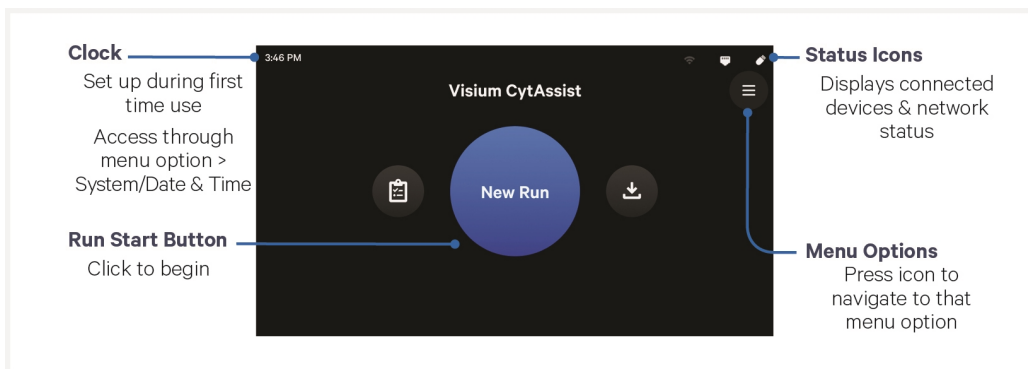

- b. Prepare Probe Release Mix shortly before use. Probe Release Mix is viscous. Pipette mix thoroughly until solution is homogenous. Avoid generating bubbles. Maintain on ice.

Probe Release Mix	10x PN	2 Tissue Slides (µl) (includes overage)
Nuclease-free Water	-	15.8
RNase Buffer B	2000551	50.0
RNase Enzyme	3000593	4.5
Total	-	70.3

c. Prepare 10% Eosin shortly before use. Vortex and centrifuge briefly.

6.5 mm Slides				
10% Eosin	10x PN	1X (µl)	2X +10% (µl)	4X +10% (µl)
Alcoholic Eosin	-	15	33	66
1X PBS	-	135	297	594
Total	-	150	330	660

11 mm Slides				
10% Eosin	10x PN	1X (µl)	2X +10% (µl)	4X +10% (µl)
Alcoholic Eosin	-	30	66	132
1X PBS	-	270	594	1,188
Total	-	300	660	1,320

d. Press blue Run Start Button on the touchscreen to initiate run.

e. Enter new run information, including:

- Visium Slide serial number. Ensure serial number is accurate.
- Custom run name, temperature, and time (**37°C** for **30 min** is recommended for most applications)
- Sample names

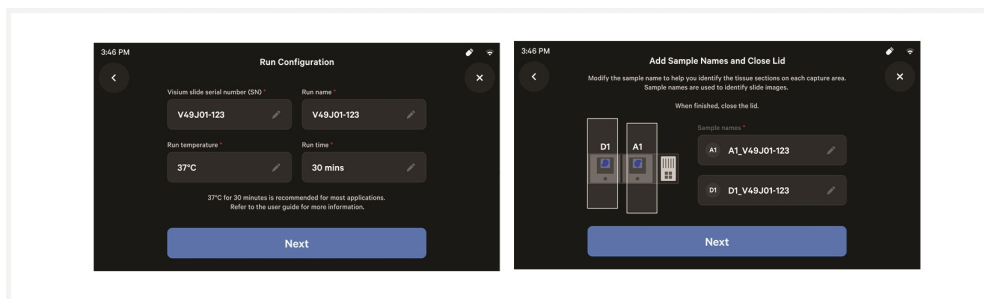

f. Using a pipette, remove all 2X SSC Buffer from the wells of the tissue slide.

g. Remove tissue slide from Tissue Slide Cassette. See Visium CytAssist Tissue Slide Cassette Removal for instructions.

h. Add **150 µl** or **300 µl** 10% Eosin to uniformly cover each tissue section per slide.

i. Incubate **1 min** at **room temperature**.

- j.** Remove 10% Eosin by holding slide at an angle over a liquid waste container.
- k.** While holding the slide over the liquid waste container, rinse with **1 ml 1X PBS**. **DO NOT** pipette directly onto tissue.

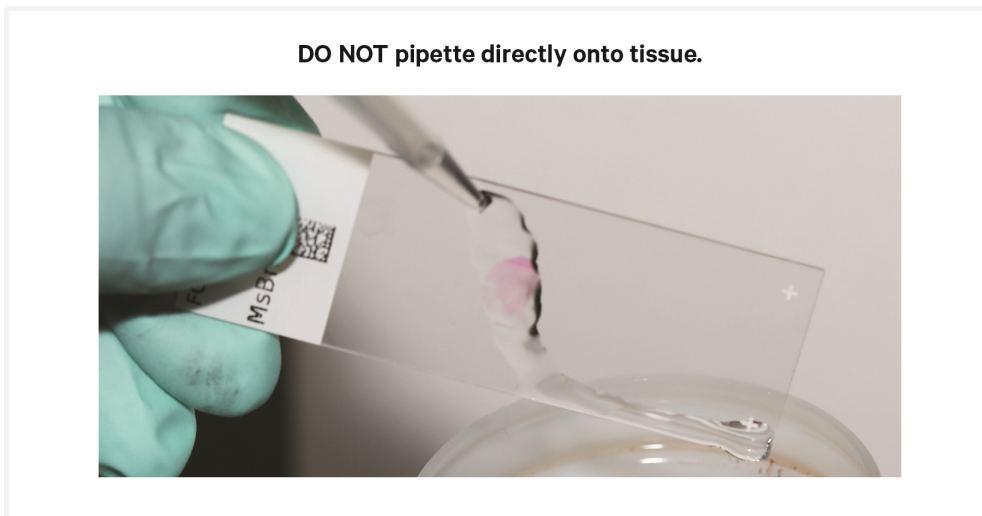

- l.** Repeat k two more times for a total of three washes.
- m.** Gently flick slide back and forth to remove excess PBS. Remove any excess PBS with a laboratory wipe without damaging the tissue sections.
- n.** Wipe back of tissue slides with a laboratory wipe and load into Visium CytAssist. See Loading Guidelines for more information.

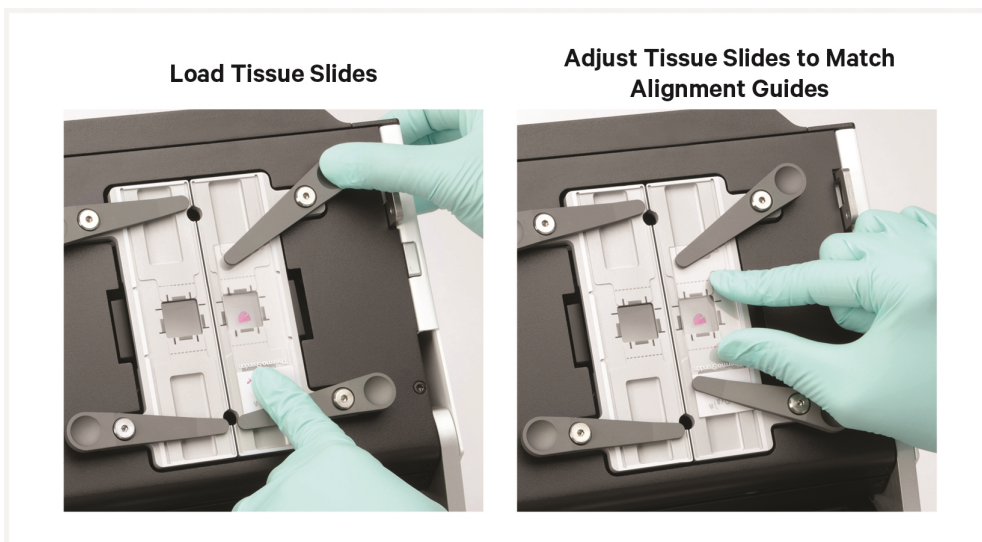

- o.** Load Visium CytAssist Spatial Gene Expression Slide onto Visium Slide Stage and close Visium Slide Lock.



**Secure Slide with One Hand
and Slowly Close Lock with
the Other**

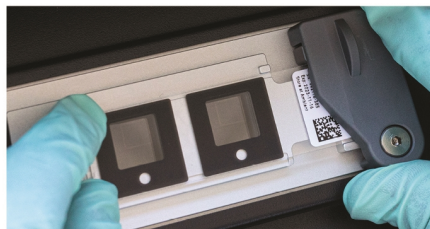

**Visium Slide Stage is Loaded
Correctly with One Slide**



CORRECT

Slide fits inside the grooves.
Label on the right is partially
obscured by the lock.
Capture areas line up with
alignment windows.

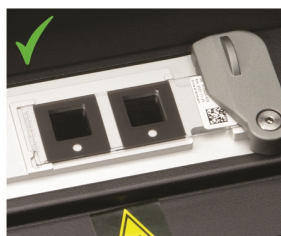

INCORRECT

Slide does not fit inside the
grooves.
Capture areas do not line up
with alignment windows.



INCORRECT

Label is on the left.
Capture areas do not line up
with alignment windows.



- p.** Remove Probe Release Mix from ice.
- q.** Pipette mix Tissue Removal Enzyme (PN-3000387) and centrifuge briefly. Add **4.7 μ l** of Tissue Removal Enzyme to **70.3 μ l** of Probe Release Mix (prepared at step 3.1b). Pipette mix 15x with pipette set to 50 μ l. Centrifuge for **5 sec**.



The time between the addition of Tissue Removal Enzyme to Probe Release Mix and starting the Visium CytAssist experiment run should be less than **5 min**.

- r.** Dispense **25 μ l** of Probe Release Mix into each spacer well on the Visium CytAssist Spatial Gene Expression Slide. Avoid generating bubbles.



- s.** Close the lid.

The home screen will now display a play symbol and run information along the bottom of the screen.

- t.** Press the play button to start the run. **37°C** for **30 min** is recommended for most applications.
- Midrun progress bar will show the time remaining in the run.

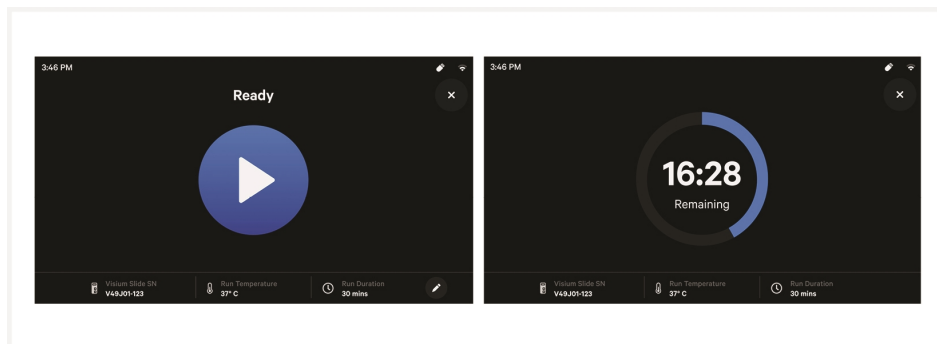

- Yellow before a run begins indicates a user-recoverable error. If an error occurs, follow on screen prompts.
- u. Prepare a thermal cycler with the following incubation protocol and start the program.

Lid Temperature	Reaction Volume	Run Time
45°C (lid may be turned off if the instrument doesn't enable 45°C)	100 µl	15 min

Step	Temperature	Time
Pre-equilibrate	45°C	Hold
Probe Extension	45°C	00:15:00
Hold	4°C	Hold

- v. Prepare Probe Extension Mix. Pipette mix. Maintain on ice.



6.5 mm Slides					
	Probe Extension Mix	10x PN	1X (µl)	2X +10% (µl)	4X +10% (µl)
●	Extension Buffer	2000409	73.5	161.7	323.4
●	Extension Enzyme	2000389	1.5	3.3	6.6
	Total	-	75.0	165.0	330.0



11 mm Slides					
	Probe Extension Mix	10x PN	1X (µl)	2X +10% (µl)	4X +10% (µl)
●	Extension Buffer	2000409	196.0	431.2	862.4
●	Extension Enzyme	2000389	4.0	8.8	17.6
	Total	-	200.0	440.0	880.0

-  **w.** At the end of a run, the button will display "Done" and a "Run Info" tab at the bottom of the screen. **DO NOT** allow sample to sit in the Visium CytAssist after run completion. **Immediately** move to next step.
- Green indicates a successfully completed run.
 - Red indicates a failed run/error.
 - Yellow at the end of a run indicates an incomplete run.

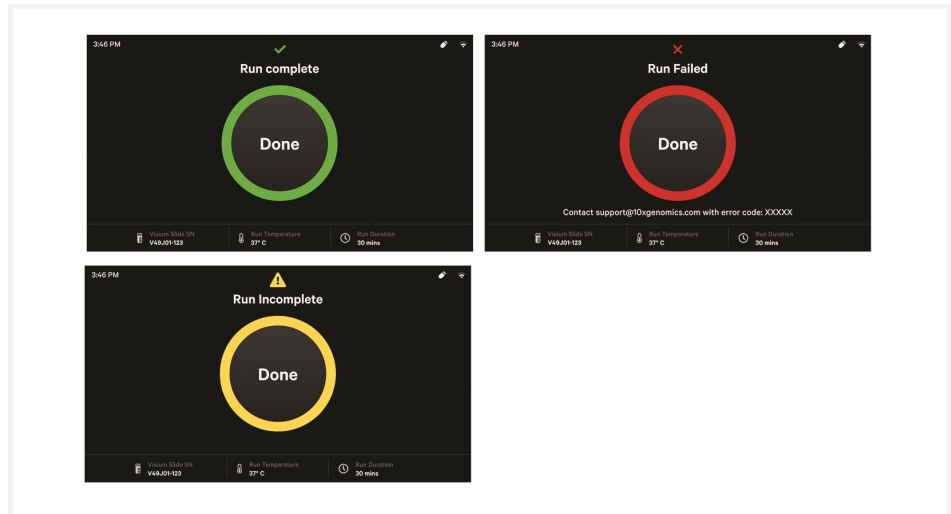

- x.** Click the "Done" button and open the lid. **DO NOT** power off the instrument at this time, as it needs to process support data. Slide may move after opening instrument.
- y.** Remove Visium CytAssist Spatial Gene Expression slide. It is normal if tissue remains on the tissue slides after run completion.

- z.** While holding the Visium CytAssist Spatial Gene Expression slide over the liquid waste container, rinse each Capture Area with **1 ml** 2X SSC. **DO NOT** pipette directly onto Capture Areas.

Rinse slide near Visium CytAssist instrument to ensure prompt washing of the arrays.

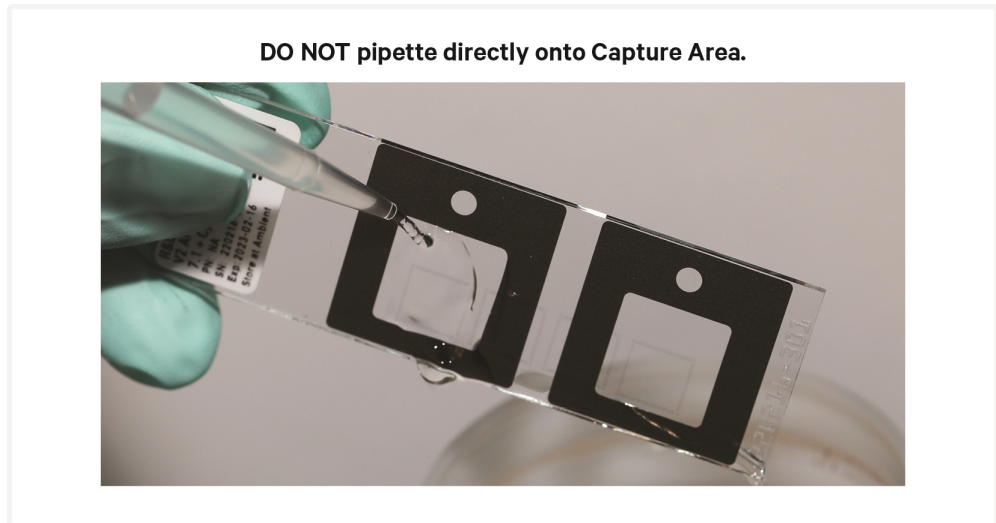

- aa.** Repeat step z two more times for a total of three washes per Capture Area.
- ab.** Place Visium CytAssist Spatial Gene Expression slide in a new 6.5 or 11 mm Visium Cassette.
- See Visium Cassette section for more information. Some moisture remaining on the Visium CytAssist Spatial Gene Expression slide is normal.
- ac.** Proceed immediately to Probe Extension. CytAssist instrument should only be cleaned and data transferred at a safe stopping point.

3.2 Probe Extension

■ denotes volumes for 6.5 mm slides and ▲ denotes volumes for 11 mm slides.

Seal for the Visium Cassette should not be cut.



- a. Add ■ **75 μ l** or ▲ **200 μ l** Probe Extension Mix to each well (to A1 and D1 if using a 6.5 mm cassette). Gently tap the Visium Cassette to ensure uniform coverage of the Capture Area.

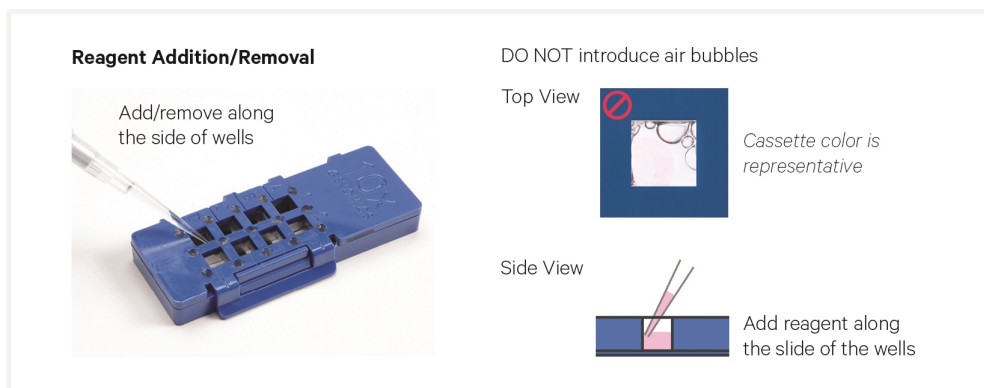

- b. Apply a new uncut Visium Slide Seal on the Visium Cassette and place on the Low Profile Thermocycler Adapter on the pre-heated thermal cycler. Close the thermal cycler lid.
- c. Skip Pre-equilibrate step to initiate Probe Extension.
-  d. Sample may remain at **4°C** in the thermal cycler for up to **24 h**. This is a safe stopping point to unload and clean the CytAssist instrument. Consult the Visium CytAssist Instrument User Guide (CG000542) for more information.

3.3 Probe Elution

■ denotes volumes for 6.5 mm slides and ▲ denotes volumes for 11 mm slides.

- a. Prepare 0.08 M KOH Mix according to the appropriate table shortly before use, adding reagents in the order listed. Vortex and centrifuge briefly. Maintain at **room temperature**.



6.5 mm Slides

KOH Mix	Stock	Final	1X (μl)	2X +10% (μl)	4X +10% (μl)
Nuclease-free Water	-	-	49.5	108.9	217.8
KOH	8 M	0.08 M	0.5	1.1	2.2
Total	-	-	50.0	110.0	220.0



11 mm Slides

KOH Mix	Stock	Final	1X (μl)	2X +10% (μl)	4X +10% (μl)
Nuclease-free Water	-	-	198.0	435.6	871.2
KOH	8 M	0.08 M	2.0	4.4	8.8
Total	-	-	200.0	440.0	880.0

- b. Remove the Visium Cassette from the Low Profile Thermocycler Adapter and place on a flat, clean work surface after the Probe Extension is complete.
- c. Remove the Visium Slide Seal and using a pipette, remove all Probe Extension Mix from the wells.
- d. Add ■ **100 μl** or ▲ **200 μl** 2X SSC Buffer prepared at step 2.1 to each well (A1 and D1 if using a 6.5 mm cassette).
- e. Remove all 2X SSC Buffer from the wells.
- f. Add ■ **50 μl** or ▲ **200 μl** 0.08 M KOH Mix to each well (A1 and D1 if using a 6.5 mm cassette). Gently tap the Visium Cassette to ensure uniform coverage of the Capture Area.
- g. Incubate at **room temperature** for **10 min**.
- h.  Transfer all solution for each sample containing the ligation product to a tube in an 8-tube strip if using a 6.5 mm cassette, or 1.5 ml microcentrifuge tube if using an 11 mm cassette. **DO NOT** leave behind

any solution in the wells. Failure to neutralize may result in a loss of signal and lower library complexity. See *Tips & Best Practices for reagent removal instructions*.

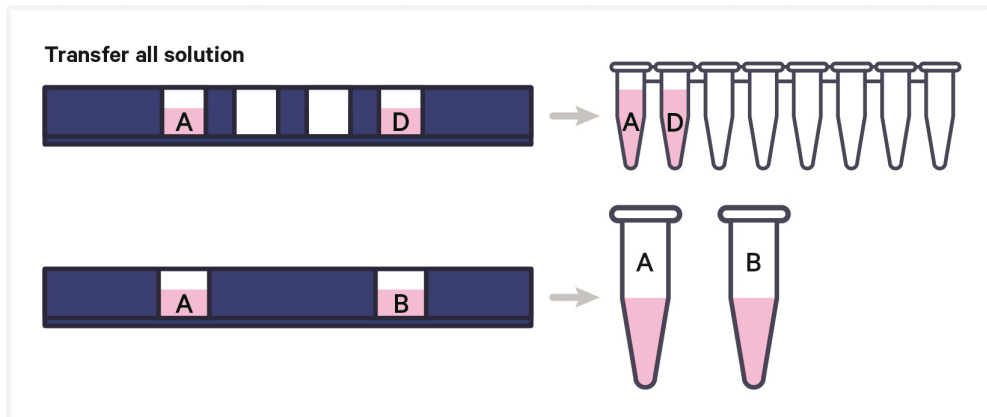

- i. Add **■ 3 μl** or **▲ 12 μl** 1 M Tris-HCl pH 8.0 to each sample. Vortex, centrifuge briefly, and place on ice.
- j. If using 11 mm Slides, divide each **212 μl** neutralized sample among four tubes in an 8-tube strip so that each tube contains **53 μl** of the neutralized sample. If necessary, add enough nuclease-free water to arrive at the correct volume.

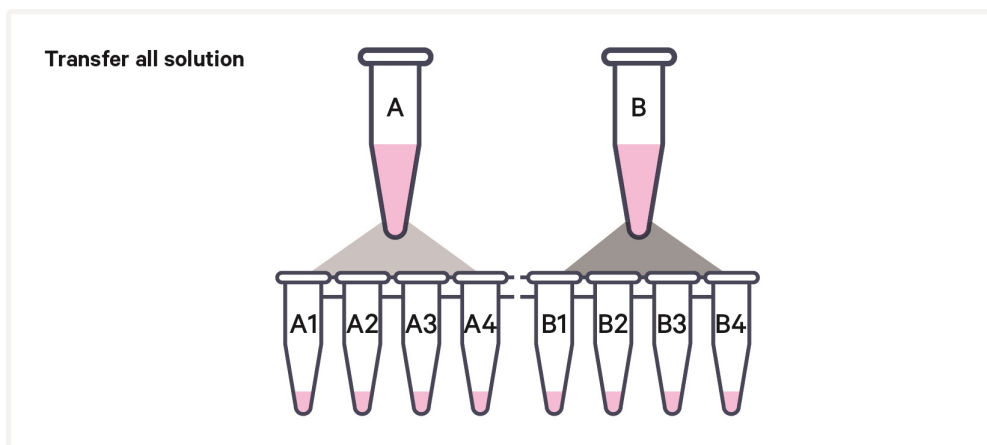

Step 4:

Pre-Amplification and SPRIselect

4.0 Get Started	86
4.1 Pre-Amplification	87
4.2 Pre-Amplification Cleanup - SPRIselect	89



4.0 Get Started

Item	10x PN	Preparation & Handling	Storage
Equilibrate to room temperature			
<input type="checkbox"/> ●	TS Primer Mix B 2000537	Thaw at room temperature, vortex, and centrifuge briefly.	-20°C
<input type="checkbox"/>	Beckman Coulter SPRIselect Reagent -	Manufacturer's recommendations.	-
Place on ice			
<input type="checkbox"/> ○	Amp Mix B 2000567	Vortex, centrifuge briefly.	-20°C
Obtain			
<input type="checkbox"/>	Qiagen Buffer EB -		Ambient
<input type="checkbox"/>	10x Magnetic Separator 230003	See Tips & Best Practices.	Ambient
<input type="checkbox"/>	80% Ethanol -	Prepare fresh.	Ambient

4.1 Pre-Amplification



If working with samples from 11 mm slides, note that during Probe Elution, each 11 mm sample was split into four replicate tubes in an 8-tube strip. Thus, all reactions during pre-amplification will have four times the number tubes as Capture Areas.

- a. Prepare Pre-Amplification Mix on ice according to the appropriate table. Add reagents in the order listed. Pipette mix and centrifuge briefly. Maintain on ice.



6.5 mm Slides					
	Pre-Amplification Mix	PN	1X (μl)	2X + 10% (μl)	4X + 10% (μl)
○	Amp Mix B	2000567	25.0	55.0	110.0
	Nuclease-free Water		19.5	42.9	85.8
●	TS Primer Mix B	2000537	2.5	5.5	11.0
	Total	-	47.0	103.4	206.8



11 mm Slides					
	Pre-Amplification Mix	PN	1X* (μl)	2X* + 10% (μl)	4X* + 10% (μl)
○	Amp Mix B	2000567	100	220	440
	Nuclease-free Water		78	171.6	343.2
●	TS Primer Mix B	2000537	10	22	44
	Total	-	188	413.6	827.2

*Refers to original number of Capture Areas

- b. Add **47 μl** Pre-Amplification Mix to each tube from step 3.3 Probe Elution (regardless of slide type). Pipette mix and centrifuge briefly.

c. Incubate in a thermal cycler with the following protocol.

Lid Temperature	Reaction Volume	Run Time
105°C	100 µl	~30-45 min
Step	Temperature	Time <i>hh:mm:ss</i>
1	98°C	00:03:00
2	98°C	00:00:15
3	63°C	00:00:20
4	72°C	00:00:30
5	Go to Step 2, repeat 9X for a total of 10 cycles	
6	72°C	00:01:00
7	4°C	Hold

4.2 Pre-Amplification Cleanup - SPRIselect

■ denotes volumes for samples from 6.5 mm slides and ▲ denotes volumes for samples from 11 mm slides.

If using MicroAmp 8-Tube Strips, use the high position (magnet•**High**) only throughout the protocol

- a. Vortex to resuspend the SPRIselect reagent. Add **120 µl** SPRIselect reagent (1.2X) to each pre-amplification reaction in an 8-tube strip (100 µl) and pipette mix 15x (pipette set to 175 µl).
- b. Incubate **5 min** at **room temperature**.
- c. Place on the magnet•**High** until the solution clears.
- d. Remove the supernatant.
- e. Add **300 µl** 80% ethanol to the pellet. Wait **30 sec**. Pipette carefully as **300 µl** is at tube limit.
- f. Remove the ethanol.
- g. Add **200 µl** 80% ethanol to the pellet. Wait **30 sec**.
- h. Remove the ethanol.
- i. Centrifuge briefly and place on the magnet•**Low**.
- j. Remove any remaining ethanol without disturbing the beads. Air dry for **2 min**. DO NOT exceed **2 min** as this will decrease elution efficiency.
- k. Remove from the magnet. Add ■ **105 µl** or ▲ **27.5 µl** Buffer EB. Pipette mix 15x (pipette set to 100 µl for samples from 6.5 mm slides or 25 µl for samples from 11 mm slides).
- l. Incubate **2 min** at **room temperature**.
- m. Place the tube strip on the magnet •**High** for samples from 6.5 mm slides or •**Low** for samples from 11 mm slides until the solution clears.
- n. For samples from 6.5 mm slides, transfer **100 µl** sample to a new tube strip.

For samples from 11 mm slides, pool replicate samples together (Four **25 µl** samples for a total of **100 µl** per capture area), vortex and centrifuge briefly.
-  o. Store at **4°C** for up to **72 h**, **-20°C** for up to **4 weeks**, or proceed to next step.

After this point in the protocol, all instructions are the same regardless of slide type used.

Step 5:

Visium CytAssist Spatial Gene Expression – Probe-based Library Construction

5.0 Get Started	91
5.1 Cycle Number Determination - qPCR	92
5.2 GEX Sample Index PCR	94
5.3 GEX Post-Sample Index PCR Cleanup - SPRIselect	96
5.4 GEX Post-Library Construction QC	97



5.0 Get Started

Item	10x PN	Preparation & Handling	Storage
Equilibrate to room temperature			
<input type="checkbox"/> ● TS Primer Mix B	2000537	Thaw at room temperature, vortex, and centrifuge briefly. Dilute amount needed for assay 1:10 in nuclease-free water.	-20°C
<input type="checkbox"/> Dual Index Plate TS Set A	3000511	Thaw at room temperature, vortex, and centrifuge briefly.	-20°C
<input type="checkbox"/> Beckman Coulter SPRlselect Reagent	-	Manufacturer's recommendations.	-
<input type="checkbox"/> Agilent TapeStation Screen Tape and Reagents If used for QC		Manufacturer's recommendations.	-
<input type="checkbox"/> Agilent Bioanalyzer High Sensitivity DNA kit If used for QC	-	Manufacturer's recommendations.	-
Place on ice			
<input type="checkbox"/> ○ Amp Mix B	2000567	Vortex, centrifuge briefly.	-20°C
<input type="checkbox"/> KAPA SYBR Fast qPCR Master Mix	-	Manufacturer's recommendations.	-
Obtain			
<input type="checkbox"/> Nuclease-free Water	-	-	Ambient
<input type="checkbox"/> Qiagen Buffer EB	-		Ambient
<input type="checkbox"/> 10x Magnetic Separator	230003	See Tips & Best Practices.	Ambient
<input type="checkbox"/> 80% Ethanol	-	Prepare fresh.	Ambient

5.1 Cycle Number Determination – qPCR

- a. Prepare qPCR Mix on ice according to the table below. Add reagents in the order listed. Vortex and centrifuge briefly. Maintain on ice. Refer to Get Started table for dilution instructions.

A passive reference dye, such as ROX, may be required. Consult the Roche KAPA SYBR FAST qPCR Kit website or the appropriate qPCR system manufacturer for guidance.

Gene Expression qPCR Mix	Stock	Final	1X (µl)	3X* + 10% (µl)	5X* + 10% (µl)
KAPA SYBR FAST qPCR Master Mix Minimize light exposure	2X	1X	5.0	16.5	27.5
Diluted TS Primer Mix B Prepared in step 5.0	-	-	1.0	3.3	5.5
Nuclease-free Water	-	-	3.0	9.9	16.5
Total			9.0	29.7	49.5

*Includes 1 negative control

- b. Add **9 µl** Gene Expression qPCR Mix to one well per sample in a qPCR plate (a well for negative control may be included).
- c. Dilute sample (1:5 in nuclease-free water) from Pre-Amplification Cleanup - SPRIselect. Pipette mix, centrifuge briefly.
- d. Transfer **1 µl** diluted sample from Pre-Amplification Cleanup - SPRIselect to each qPCR plate well containing qPCR Mix. If using a negative control, add **1 µl** nuclease-free water to the corresponding well. Pipette mix, apply seal, and centrifuge briefly. Record which sample is in which well of the qPCR plate. Note that only **25 µl** of pre-amplification material is used to generate gene expression libraries. The remaining **75 µl** (75%) can be stored at **4°C** for up to **72 h** or at **-20°C** for up to **4 weeks** for generating additional libraries.
- e. Prepare a qPCR system with the following protocol, place the plate in the thermal cycler, and start the program.

Lid Temperature	Reaction Volume	Run Time
105°C	10 µl	35 min
Step	Temperature	Time hh:mm:ss
1	98°C	00:03:00

Lid Temperature	Reaction Volume	Run Time
2	98°C	00:00:05
3	63°C	00:00:30
 Read signal		
4	Go to step 2, 29x (total of 30 cycles) -	

f. Record the Cq Value for each sample.

Set the y-axis to a linear scale. Plot RFU on the y-axis if not using a reference dye, or ΔRn if using a reference dye. The threshold for determining the Cq value should be set along the exponential phase of the amplification plot, at ~25% of the peak fluorescence value.

Representative qPCR Amplification Plots

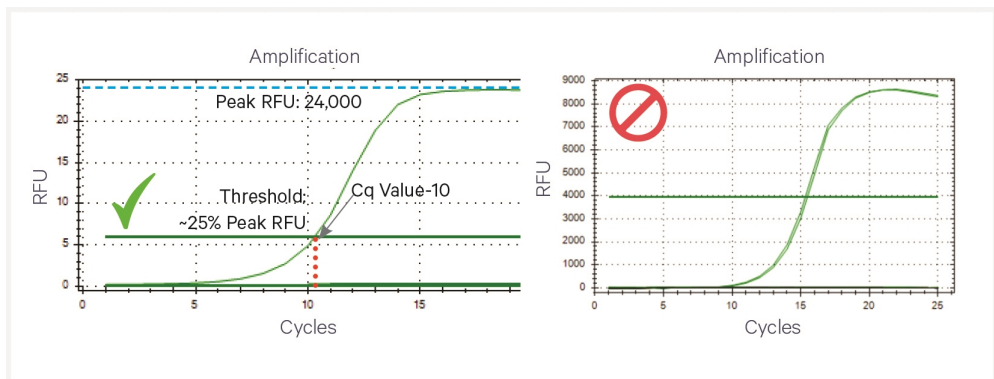

5.2 GEX Sample Index PCR



- a. Choose the appropriate sample index sets to ensure that no sample indices overlap in a multiplexed sequencing run. Record the 10x Sample Index name (PN-3000511 Plate TS Set A well ID) used.
- b. Prepare Amplification Master Mix and pipette mix 10x shortly before use.

	Amplification Master Mix	10x PN	1X (µl)	2X +10% (µl)	4X +10% (µl)
	Nuclease-free Water	-	45	99	198
○	Amp Mix B	2000567	25	55	110
	Total	-	70	154	308

- c. Add **70 µl** Amplification Master Mix to a tube in an 8-tube strip for each sample.
- d. Add **25 µl** of each sample from pre-amplification to a separate tube previously aliquotted with Amplification Master Mix.
- e. Add **5 µl** of an individual Dual Index TS Set A to each tube and record the well ID used. Pipette mix and centrifuge briefly.
- f. Incubate in a thermal cycler with the following protocol.

Lid Temperature	Reaction Volume	Run Time
105°C	100 µl	Variable
Step	Temperature	Time hh:mm:ss
1	98°C	00:03:00
2	98°C	00:00:15
3	63°C	00:00:20
4	72°C	00:00:30
5	Go to step 2, use the Cq Value +2 as the total # of cycles. See table below for total # of cycle examples.	
6	72°C	00:01:00
7	4°C	Hold

Round Cq values up to the nearest whole number and add two cycles, as shown in the examples below. Samples within ±1 cycle numbers can be combined in a single SI-PCR run at the higher cycle number. Do not combine samples if the cycle number difference is greater than 1 to avoid library over-

amplification.

Example Cycle Numbers

Cq Value from qPCR	+2	Total Cycles
7.2	+2	10
8.5	+2	11
13.7	+2	16



Any remaining pre-amplification material can be stored at **4°C** for up to **72 h** or at **-20°C** for up to **4 weeks** for generating additional libraries.

5.3 GEX Post-Sample Index PCR Cleanup – SPRIselect

If using MicroAmp 8-Tube Strips, use the high position (magnet•**High**) only throughout the protocol

- a. Vortex to resuspend SPRIselect Reagent. Add **85 µl** SPRIselect Reagent (**0.85X**) to each sample. Pipette mix 15x (pipette set to 175 µl).
- b. Incubate **5 min** at **room temperature**.
- c. Place on the magnet•**High** until the solution clears.
- d. Remove the supernatant.
- e. Add **200 µl** 80% ethanol to the pellet. Wait **30 sec**.
- f. Remove the ethanol.
- g. **Repeat** steps e and f for a total of two washes.
- h. Centrifuge briefly. Place on the magnet•**Low**.
- i. Remove any remaining ethanol. Air dry for **2 min**. DO NOT exceed **2 min** as this will decrease elution efficiency.
- j. Remove from the magnet. Add **27 µl** Buffer EB. Pipette mix 15x.
- k. Incubate **2 min** at **room temperature**.
 - l. Place on the magnet•**Low** until the solution clears.
- m. Transfer **25 µl** sample to a new tube strip.
- n. Store at **-20°C** for **long-term** storage.

5.4 GEX Post-Library Construction QC

- a. Dilute sample (1:50 dilution, i.e **1 μ l** sample in **49 μ l** of EB buffer) until it is at an appropriate concentration for the Bioanalyzer.
- b. Run **1 μ l** of sample on an Agilent Bioanalyzer High Sensitivity chip. If peak is too small or flat, re-try with a lower dilution. Refer to Troubleshooting for more information.

Representative Trace

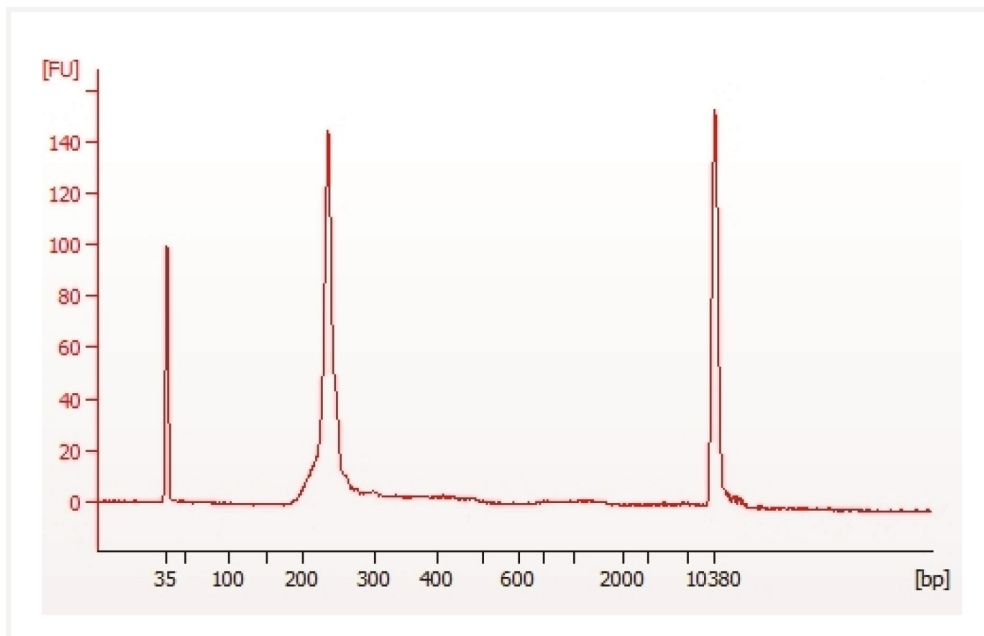

Determine the average fragment size from the Bioanalyzer trace. The expected average fragment size is 240 bp. This will be used as the insert size for library quantification.

Alternate QC Method:

- Agilent TapeStation
- LabChip

See [Appendix on page 118](#) for representative traces

See [Post Library Construction Quantification on page 119](#)

Sequencing

Sequencing Libraries	99
Sequencing Depth	99
Sequencing Type & Run Parameters	100
Illumina Sequencer Compatibility	100
Sample Indices	101
Library Loading	101

Sequencing Libraries

Libraries comprise standard Illumina paired-end constructs which begin with P5 and end with P7. 16 bp Spatial Barcodes are encoded at the start of TruSeq Read 1 (Read 1T), while i7 and i5 sample index sequences are incorporated as the index read. TruSeq Read 1 (Read 1T), and Small RNA Read 2 (Read 2S) are standard Illumina sequencing primer sites used in paired-end sequencing. TruSeq Read 1 are used to sequence the 16 bp Spatial Barcode and 12 bp UMI. Small RNA Read 2 (Read 2S) is used to sequence the Ligated Probe Insert. Sequencing these libraries produces a standard Illumina BCL data output folder.

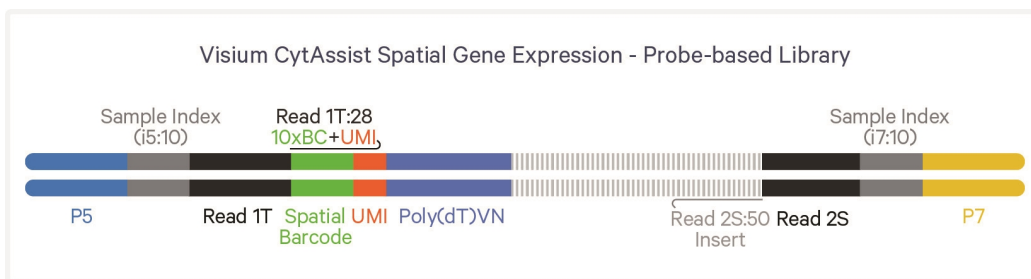

Sequencing Depth

Calculating sequencing depth requires estimating the approximate Capture Area (%) covered by tissue. This may be performed visually or by using the Visium Manual Alignment Wizard in Loupe Browser for a more accurate measurement. See examples below for estimating coverage area visually. If using Loupe Browser, the number of spots covered by tissue will be displayed during the “Identify Tissue” step. For more information, consult the 10x Genomics Support website.

The examples below are for 6.5 mm slides. The total number of spots/Capture Area should be adjusted based on the Capture Area size (the number of spots for 6.5 mm slides is 4,992 and the number of 11 mm slides is 14,336).

Sequencing Depth/spot	Minimum 25,000 read pairs per tissue covered spot on Capture Area
Sequencing Depth/sample	See example calculation below

Example: Sequencing Depth for a Sample

- **Estimate the approximate Capture Area (%)**
covered by the tissue section.
- **Calculate total sequencing depth=**
(Coverage Area x total spots on the Capture Area)
x 25,000 read pairs/spot
- **Example calculation for 60% coverage:**
(0.60 x 5,000 total spots) x 25,000 read pairs/spot=
75 million total read pairs for that sample

Estimated Coverage Area (%) Examples

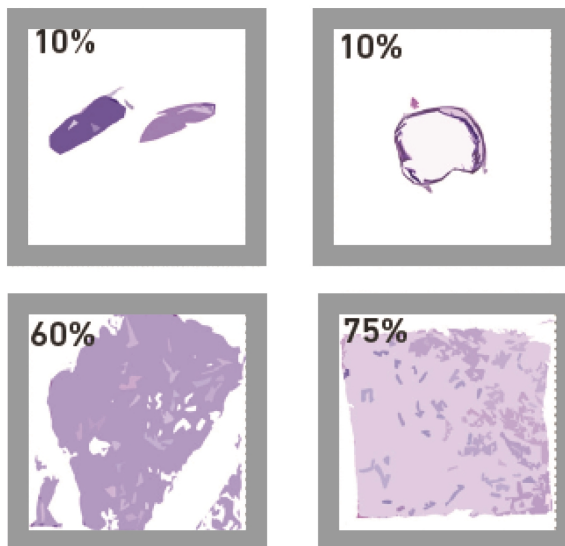

Sequencing Type & Run Parameters

Use the sequencing run type and parameters indicated.

Dual Index Library

Paired-end, dual indexed sequencing

Read 1: 28 cycles
i7 Index: 10 cycles
i5 Index: 10 cycles
Read 2S: 50 cycles*

*Visium CytAssist Spatial Gene Expression - Probe-based libraries generated with this User Guide may be pooled with Visium Spatial Gene Expression libraries generated from fresh frozen samples (generated with Document CG000239). If pooling the two different library types, Visium CytAssist Spatial Gene Expression - Probe-based libraries should not occupy more than 40% of the pool to balance clustering efficiency differences across sequencing pools.

Illumina Sequencer Compatibility

The compatibility of the listed sequencers has been verified by 10x Genomics. Some variation in assay performance is expected based on sequencer choice. For more information about performance variation, visit the 10x Genomics Support website.

- MiSeq
- NextSeq 500/550
- NextSeq 2000
- NovaSeq
- iSeq

Sample Indices

Each well of the Dual Index Kit TS Set A (PN-1000251) contains a mix of one unique i7 and one unique i5 sample index. If multiple samples are pooled in a sequence lane, the sample index name (i.e. the Dual Index TS Set A plate well ID, SI-TS-) is needed in the sample sheet used for generating FASTQs with “spaceranger mkfastq”. Samples utilizing the same sample index should not be pooled together or run on the same flow cell lane, as this would not enable correct sample demultiplexing.

Library Loading

Once quantified and normalized, libraries should be denatured and diluted as recommended for Illumina sequencing platforms. Refer to Illumina documentation for denaturing and diluting libraries. Refer to the 10x Genomics Support website, for more information.

Instrument	Loading Concentration (pM)	PhiX (%)
MiSeq	11	1
NextSeq 500/550	1.8	1
NextSeq 2000	650	1
NovaSeq	150**/300	1
iSeq	150	1

** Use 150 pM loading concentration for Illumina XP workflow.

Troubleshooting



Bubbles during Coverslipping	103
Bubbles Trapped During Visium CytAssist Run	103
Reagent Flow Failure	104
Visium CytAssist Overheating	105
Slide Popped Off of Visium Slide Stage	105
Number of Washes	105
Tissue Detachment and Folding	107
Tissue Not Within Allowable Area	108
Tissue Outside of Specifications	109
Tissue Segmentation Failure	110
Gasket Obscures Capture Area	111
Visium CytAssist Slide Removal Delayed	112
No qPCR Amplification	112
Flat Line in BioAnalyzer Library Trace	113
Overloaded or Overamplified Trace	114
Delayed Addition of Tissue Removal Enzyme to Probe Release Mix	116
Incorrect Thermal Cycler Ramp Rate	117

Bubbles during Coverslipping

A bubble could be generated during coverslipping.

Bubbles may cause blackening of tissue

H&E Stain

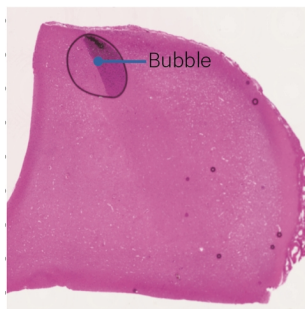

A bubble could be generated during coverslipping. Avoid generating bubbles during mounting medium dispensing by pipetting slowly and avoiding expelling air from the pipette tip. If the bubble is on the tissue, blackening of the tissue could occur. However, this does not diminish sensitivity and spatial resolution, and the data derived from the blackened area can still be analyzed.

Bubbles Trapped During Visium CytAssist Run

Bubbles may Result in no Usable Sequencing Reads during the CytAssist Assay

Eosin Stained Tissue

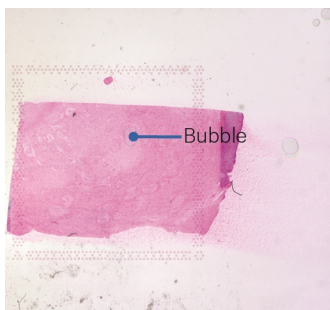

Some eosin may be washed off during an instrument run, as shown on the right side of this image. This does not affect performance.

UMI Counts

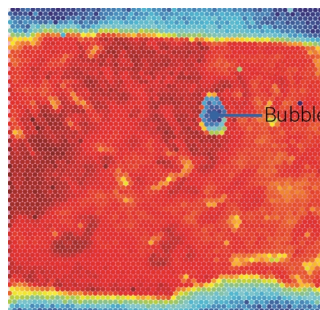

Bubbles during a Visium CytAssist experiment run are rare, but may result in a lack of useable reads in the tissue area where the bubbled occurred. Avoid generating bubbles during reagent dispensing by pipetting slowly and avoiding expelling air from the pipette tip.

Reagent Flow Failure

Inappropriate flow of reagents during a Visium CytAssist experiment run may result in transcript mislocation. If UMI map appears abnormal (>50% of UMIs outside of tissue), contact support@10xgenomics.com.

Ensure that frosted areas of slide are not within the dashed zone on the Visium Tissue Slide Stage. Keep Visium Spatial and tissue slides free from dust and debris. After Eosin wash, remove as much PBS as possible by flicking the tissue slide and wiping any remaining droplets around tissue with a laboratory wipe.

Visium CytAssist Overheating

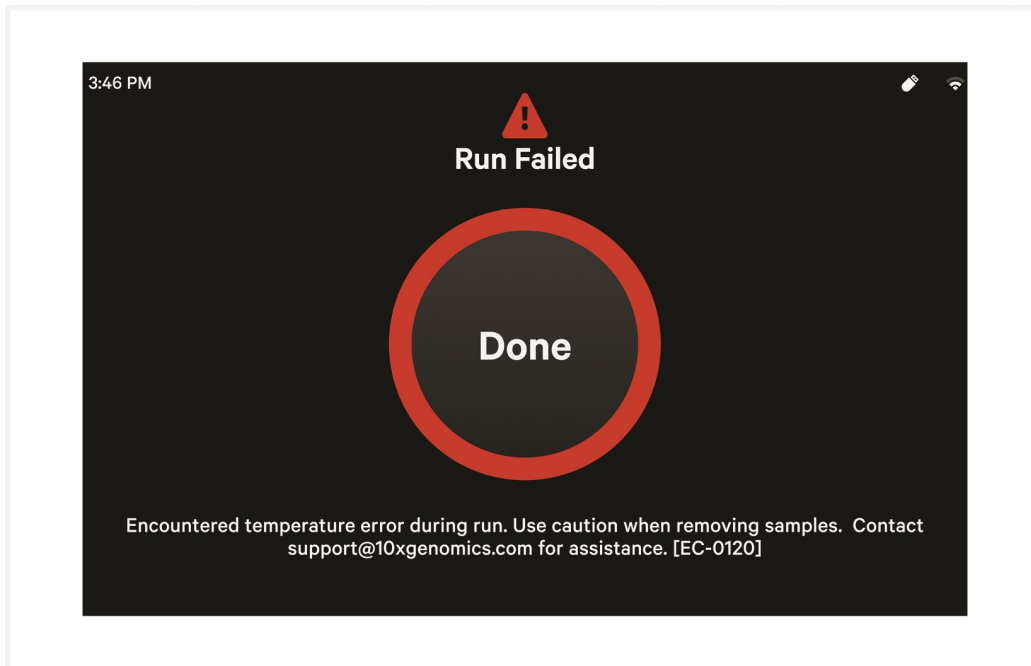

If the Visium CytAssist instrument overheats during an experiment run, the run will fail. A warning message will appear instructing users to carefully remove slides and contact support@10xgenomics.com.

Slide Popped Off of Visium Slide Stage

Upon opening the lid after a successful run, the Visium slide may pop out of the grooves on the Visium Slide Stage. This does not impact assay performance or slide quality.

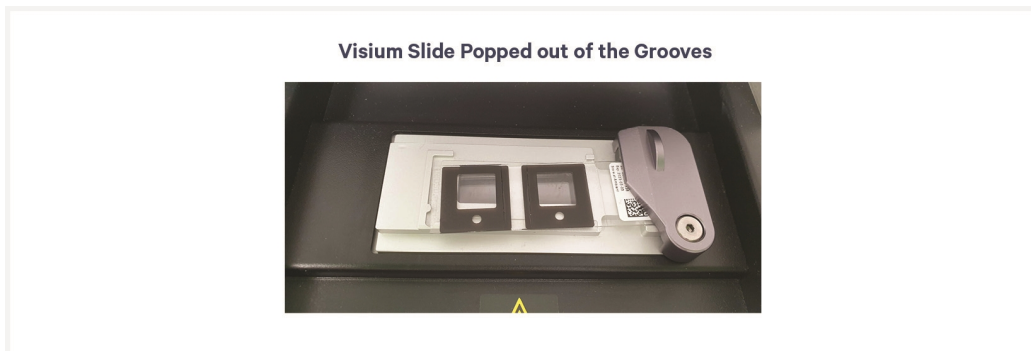

Number of Washes

Post hybridization and post ligation washes are critical for assay performance. Failure to perform the correct number of washes can reduce the fraction of

targeted reads usable (see table below). A similar effect is observed when washing for less than the recommended 5 min, or when reagent is carried over during the washes. Remove all liquid from the well when washing, and refer to User Guide for correct number of washes and incubation times.

Wash	Number of Washes	Fraction Targeted Reads Usable (Mean)
Post Hybridization Wash	1	0.29
	2	0.41
	3	0.79
Post Ligation Washes	1	0.69
	2	0.75

Tissue Detachment and Folding

Tissue detachment may result in a lack of useable reads in the region where detachment occurred. If the tissue has folded on itself, this may also cause elevated UMI counts in the overlapping areas. Inspect images carefully to identify these areas. Ensure that slides tested by 10x Genomics were used for tissue placement. If tissue detachment is observed during this workflow, contact support@10xgenomics.com

Tissue Detachment May Cause a Loss of Gene Expression

IF Stained Tissue

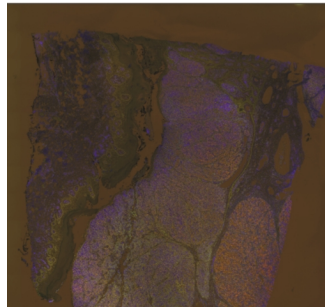

CytAssist Image



UMI Count

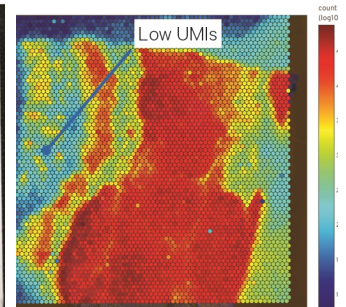

Tissue Folding May Cause Elevated UMI Counts

H&E Stained Tissue

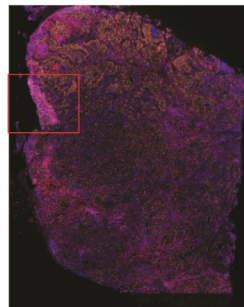

CytAssist Image

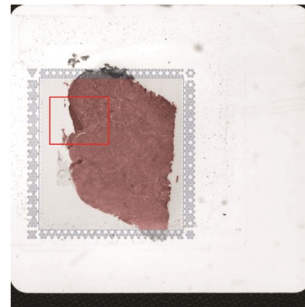

UMI Count

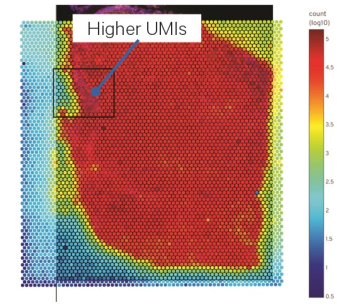

Tissue Not Within Allowable Area

Tissue Outside of Allowable Area is Not Analyzed

Tissue Larger than Capture Area

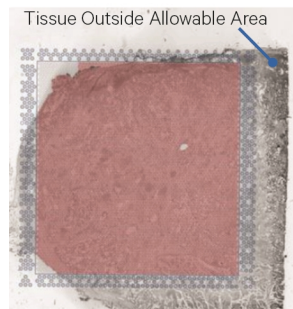

Tissue Not Properly Aligned



Tissues that are not placed within the allowable area on approved glass slides will not be analyzed. This may occur if the tissue is larger than the Capture Area or if the tissue slide is not properly aligned when loading into the CytAssist instrument. Refer to [CytAssist Validated Slides](#) for guidance on allowable areas.

Tissue Outside of Specifications

FFPE tissue sections should be between 3 and 10 μm . FF and FxF tissue sections should be between 10 and 20 μm . Sections outside these specifications may result in reduced performance.

Thin Sections May Lead to Decreased Sensitivity

H&E Stained Tissue at Recommended Thickness **Mean Panel UMI Count at 20,000 Raw Reads per Spot: 14,645**

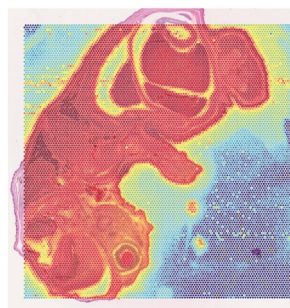
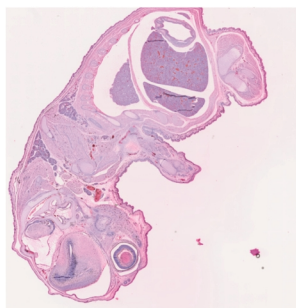

H&E Stained Tissue Below Recommended Thickness **Mean Panel UMI Count at 20,000 Raw Reads per Spot: 8,511**

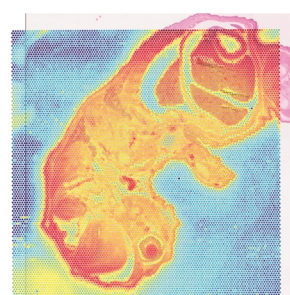
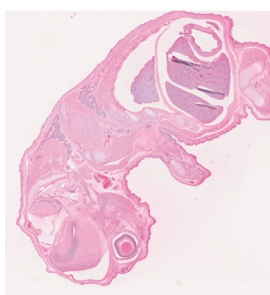

Tissue Segmentation Failure

Examples of Scenarios that Lead to Tissue Segmentation Failure

Inadequate Staining Causes Poor Tissue Segmentation



H&E Stained Tissues Outside of Gasket May Not Undergo Destaining

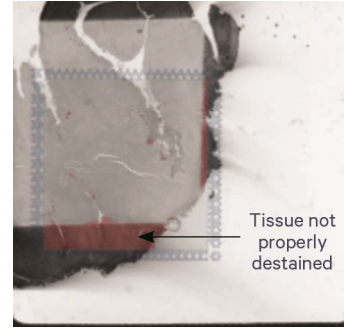

Space Ranger may fail to detect tissue for a variety of reasons which may necessitate manual fiducial alignment and tissue detection via Loupe Browser. Two example scenarios that may lead to tissue segmentation failure are described below:

- If the contrast between background and tissue is poor (due to inadequate staining, technical error, or tissue composition) tissue segmentation failure may occur (left image).
- If large tissues that exceed the gasket area of the cassette re-enter the capture area, they may cause a tissue segmentation failure in Space Ranger if they re-enter the Capture Area due to the contrast of this tissue against tissue within the Capture Area (right image).

Gasket Obscures Capture Area

Gasket Covers Portion of Tissue within Capture Area

H&E Stained Tissue

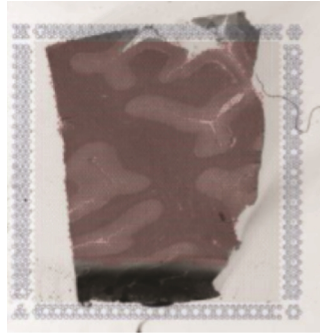

Tissue Plot with Spots Colored by Clustering

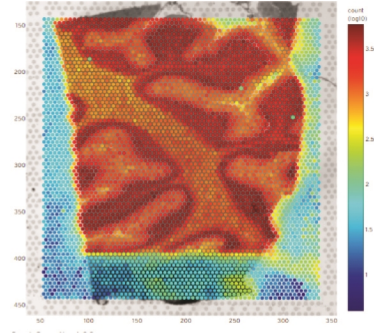

If the gasket covers a portion of the tissue within the Capture Area, that area will not be exposed to the appropriate reagents; thus, analytes will not be captured. In Loupe Browser, manual alignment must be performed to exclude the tissue area obscured by the gasket. This issue can be prevented by ensuring that the positioning of the gasket within the Tissue Slide Cassette does not obscure the Capture Area after Tissue Slide Cassette assembly.

Visium CytAssist Slide Removal Delayed

A delay in removing and processing the Visium CytAssist Spatial Gene Expression Slide after run completion may impact data quality.

No qPCR Amplification

No amplification during Cycle Number Determination may be due to the following:

- Incorrect qPCR machine programming (i.e. detecting a fluorophore other than SYBR Green)
- Issues with pipetting small volumes
- Failure to neutralize KOH
- Failure to add TS primer to pre-amp or qPCR mix
- Unusually low recovery from tissue due to high percentage of connective tissue in Capture Area
- Incorrect preparation of Probe Release Mix
- Mistake in Probe Release Mix addition timing
- Leakage from the Visium CytAssist Tissue Slide Cassette during workflow

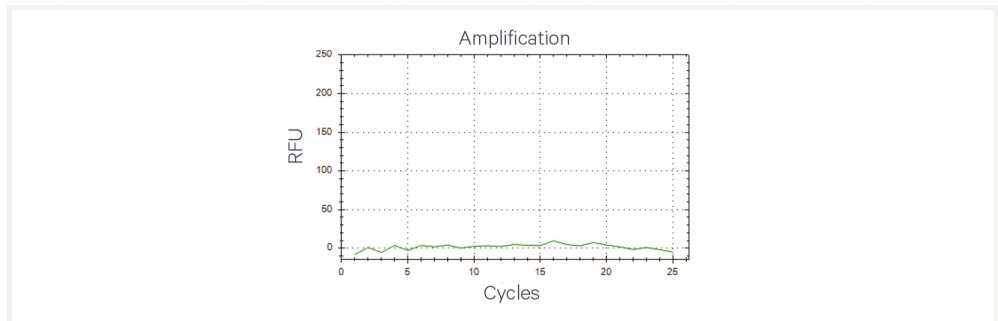

Flat Line in BioAnalyzer Library Trace

A normal qPCR output but no peak visible in the BioAnalyzer trace may be due to a mistake in the SI-PCR step, an overdilution of the final library, Bioanalyzer issue, or thermal cycler failure.

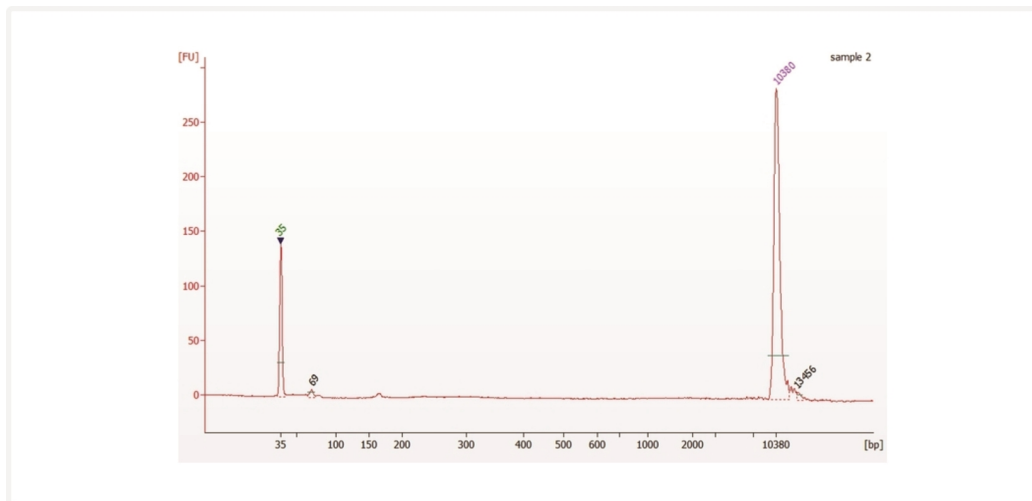

Overloaded or Overamplified Trace

Overloaded Trace

The image below is an example of an overloaded trace. Note the double peak at around 240 bp. The low and high molecular weight markers are in low abundance compared to the sample. Ensure the library was diluted 1:50 prior to loading per protocol recommendations. If the library was diluted, ensure the library concentration is within the specification range of the automated electrophoresis kit being used. The library can be quantified using a Qubit and diluted further if appropriate.

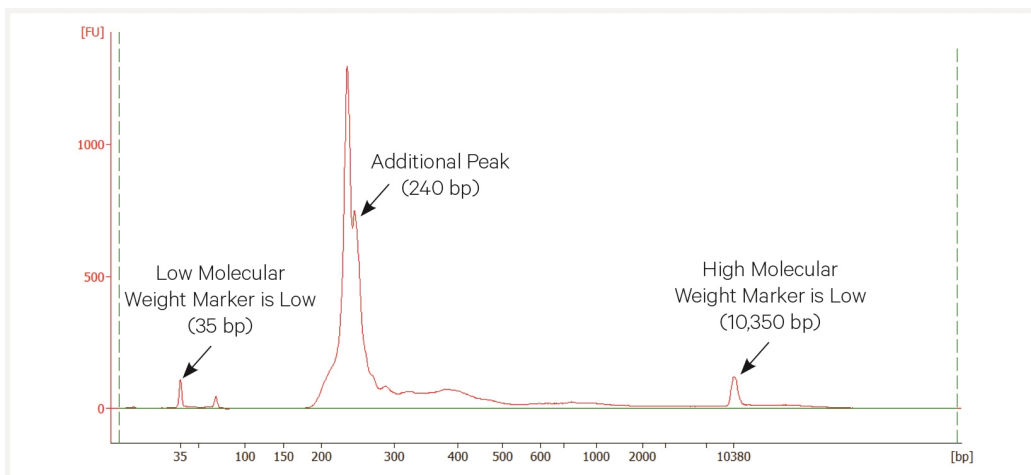

Overamplified Trace

The image below is an example of an overamplified trace. Note peak at 400 bp.

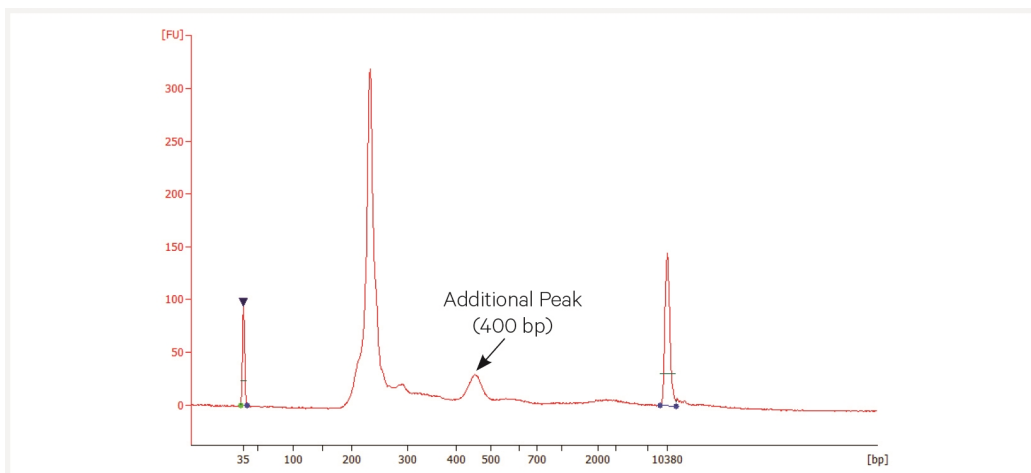

Ensure interpretation of qPCR plot is correct. If necessary, batch samples into separate SI-PCR runs if Cq is > 1 cycle. If batching samples, the cycle number determined should be ±1. If needed, select the value inbetween.

For example, a sample with C(t) value of 7.5 should go through 10 cycles during SI-PCR (round up to 8 and add 2) and a sample with a Cq value of 9.2 should go through 12 cycles during SI-PCR (round up to 10 and add 2). If running together, samples should undergo 11 cycles during SI-PCR.

Delayed Addition of Tissue Removal Enzyme to Probe Release Mix

While the effect of a delay in adding Tissue Removal Enzyme (TRE) to the Probe Release Mix (PRM) longer than ten minutes is unknown, a short delay (up to ten minutes) is shown to negatively impact assay sensitivity (median UMI counts and median genes per tissue-covered spot), but has no impact on assay quality (percent reads mapped confidently to the probe set). The time between the addition of Tissue Removal Enzyme to Probe Release Mix and starting the Visium CytAssist experiment run should be less than **5 min**.

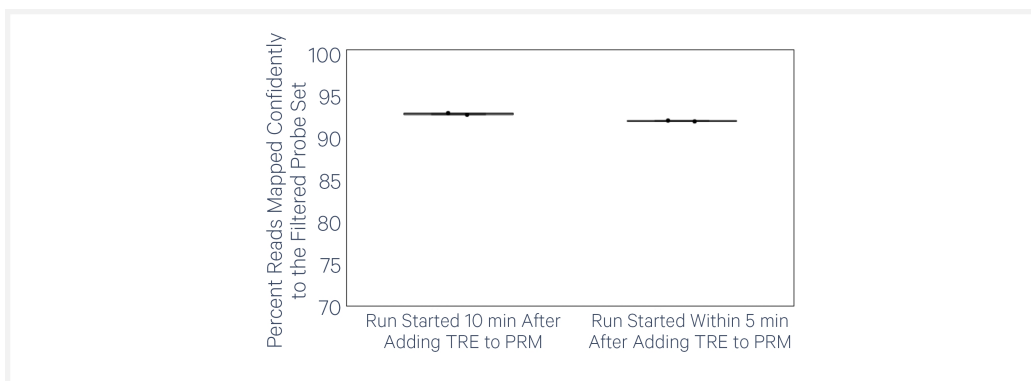

Incorrect Thermal Cycler Ramp Rate

Incorrect thermal cycler ramp rates negatively impact assay sensitivity (mean UMI counts and mean genes per tissue-covered spot), but has no impact on assay quality (reads mapped confidently to the probe set). These data show that using a Biometra TAdvanced thermal cycler at the incorrect ramp rate (8°C/sec heating and cooling) vs. the correct ramp rate (2°C/sec heating and cooling) negatively impacts assay sensitivity. Use the recommended ramp rates as described in [Recommended Thermal Cyclers on page 12](#).

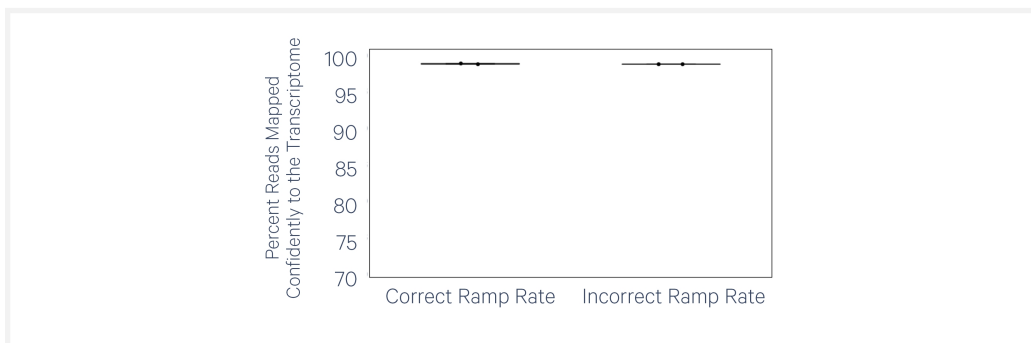
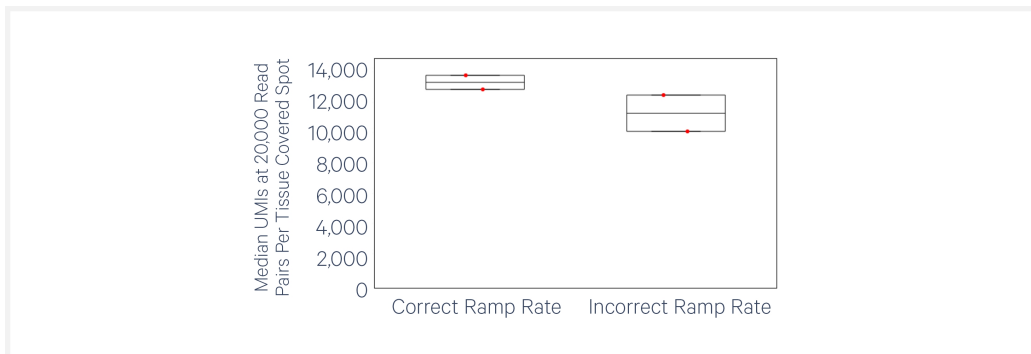
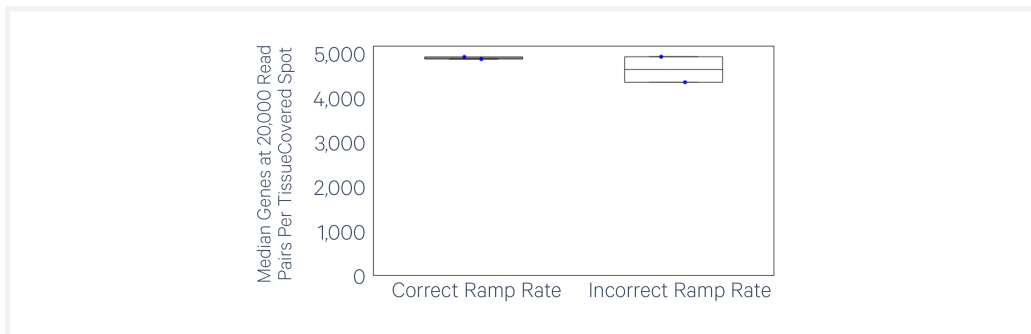

Appendix

Post Library Construction Quantification	119
Agilent TapeStation Traces	120
LabChip Traces	121
Oligonucleotide Sequences	122

Post Library Construction Quantification

- a. Thaw KAPA Library Quantification Kit for Illumina Platforms.
- b. Dilute **2 µl** sample with deionized water to appropriate dilutions that fall within the linear detection range of the KAPA Library Quantification Kit for Illumina Platforms. (For more accurate quantification, make the dilution(s) in duplicate).
- c. Make enough Quantification Master Mix for the DNA dilutions per sample and the DNA Standards (plus 10% excess) using the guidance for 1 reaction volume below.

Quantification Master Mix	1X (µl)
SYBR Fast Master Mix + Primer	12
Water	4
Total	16

- d. Dispense **16 µl** Quantification Master Mix for sample dilutions and DNA Standards into a 96 well PCR plate.
- e. Add **4 µl** sample dilutions and **4 µl** DNA Standards to appropriate wells. Centrifuge briefly.
- f. Prepare a qPCR system with the following protocol. Insert the plate and start the program.

Lid Temperature	Reaction Volume	Run Time
-	20 µl	35 min
Step	Temperature	Time
1	95°C	00:03:00
2	95°C	00:00:05
3	67°C  Read signal	00:00:30
4	Go to Step 2, 29X (Total 30 cycles)	

- g. Follow the manufacturer’s recommendations for qPCR-based quantification. For library quantification for sequencer clustering, determine the concentration based on insert size derived from the Bioanalyzer/TapeStation trace.

Agilent TapeStation Traces

Agilent TapeStation High Sensitivity D5000 ScreenTape was used. Protocol steps correspond to the steps in this User Guide.

Protocol Step 5.3 - GEX Post Library Construction QC

Representative Trace

Run manufacturer's recommended volume of diluted sample (1:50 dilution)

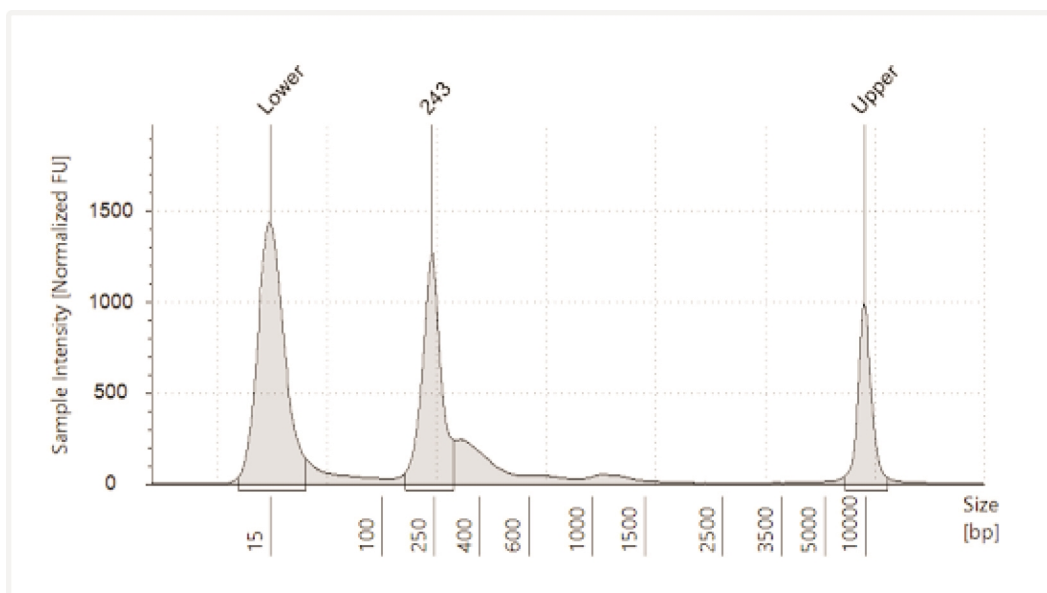

LabChip Traces

DNA High Sensitivity Reagent Kit was used. Protocol steps correspond to the steps in this User Guide.

Protocol Step 5.3 - GEX Post Library Construction QC

Representative Trace
Run manufacturer's recommended volume of diluted sample (1:5 dilution)

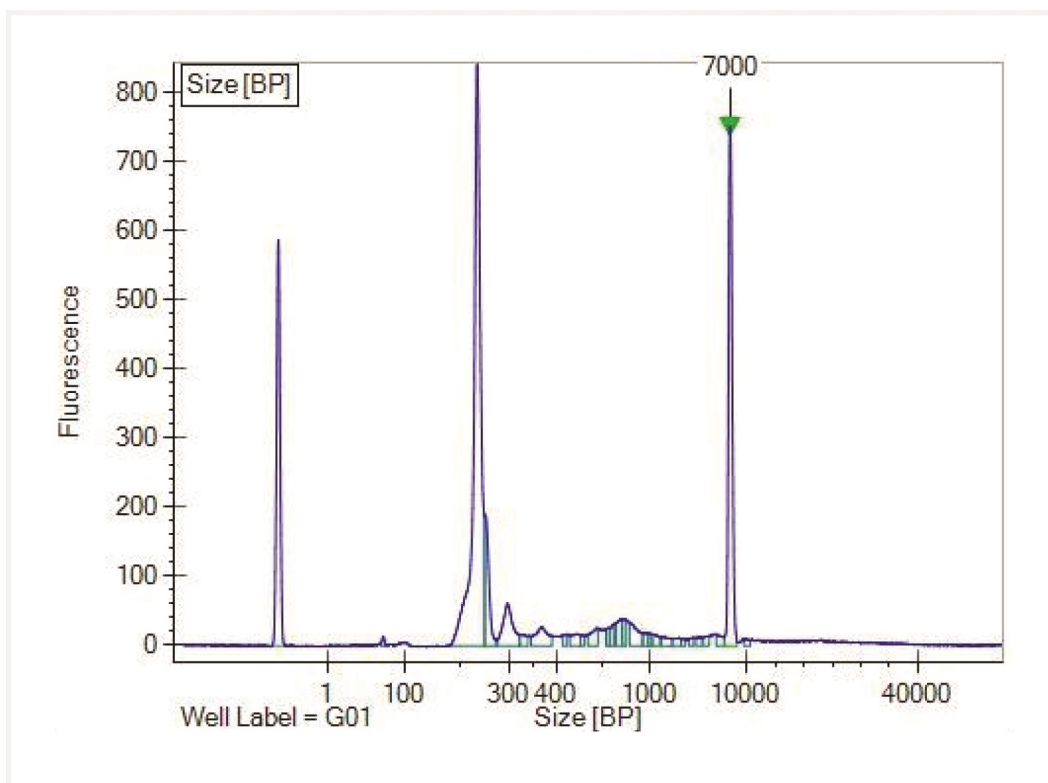

Oligonucleotide Sequences

Slide Primers

5'-CTACACGACGCTCTCCGATCT-N16-N12-TTTTTTTTTTTTTTTTTTTTTTTTTTTTTTTTTTTVN-3'



Visium CytAssist Spatial Gene Expression - Probe-based Library

